

TH-F6A/F7E

SERVICE MANUAL

KENWOOD

© 2001-8 PRINTED IN JAPAN
B51-8580-00 (S) 798

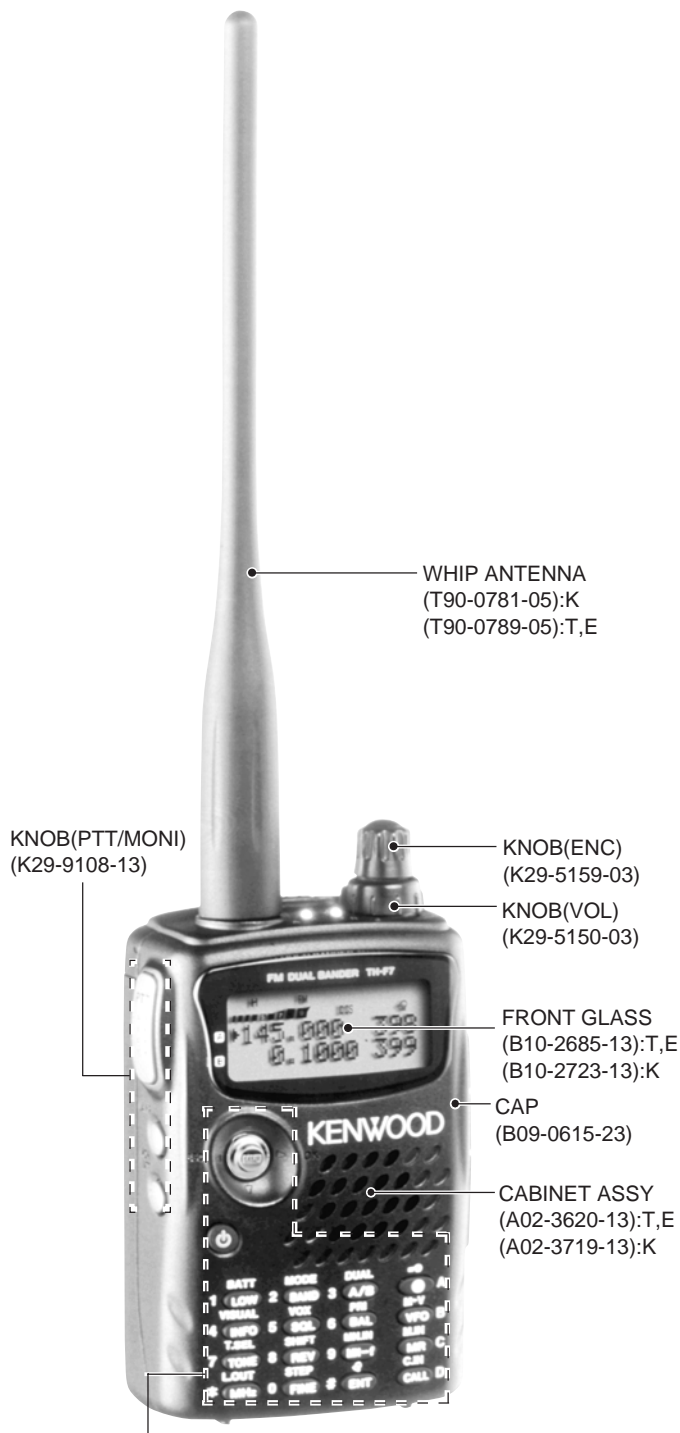

KEY TOP
(K29-9107-12)

CONTENTS

DISASSEMBLY FOR REPAIR	2
CIRCUIT DESCRIPTION	4
DESCRIPTION OF COMPONENTS	14
PARTS LIST	19
EXPLODED VIEW	32
PACKING	33
ADJUSTMENT	34
PC BOARD VIEWS	
TX-RX UNIT (CONTROL SECTION)	59
TX-RX UNIT	65
TX-RX UNIT (VCO SECTION)	71
SCHEMATIC DIAGRAM	73
BLOCK DIAGRAM	81
LEVEL DIAGRAM	83
OPTIONS	85
SPECIFICATIONS	86

TH-F6A/F7E

DISASSEMBLY FOR REPAIR

1. How to remove the case assembly from the chassis:

1. Remove 2 screws (①).
2. Remove 2 knobs (②) and 2 round nuts (③).
3. Remove the SP/MIC jack cover (④).
4. Open the bottom part of case assembly and lift the front panel from the chassis (⑤).

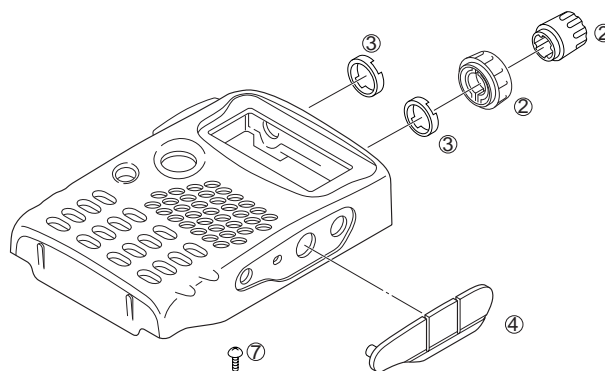

2. How to remove the main PCB:

2-1. Control section

1. Remove the SP/MIC jack cover (⑥).
2. Remove 5 screws (⑦) and lift and remove the control PCB (TX-RX A/3).
3. Extract the encoder flat cable from the connector.

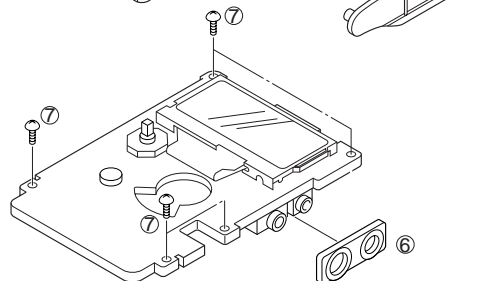

2-2. RF section

4. Remove 8 screws (⑧), and 1 round screw (⑨), then remove the RF shield cover. Remove the soldering that connects the whip antenna and bar-antenna (3 locations).
5. Remove the battery terminal screw (⑩).
6. Lift and remove the RF PCB (TX-RX B/3).

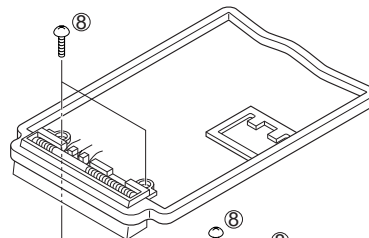

2-3. PLL/VCO section

7. Remove the soldering (8 locations) that holds the PLL/VCO shield cover (⑪) then lift the shield cover.
8. Lift the PLL/VCO PCB upward to separate it from the main PCB.

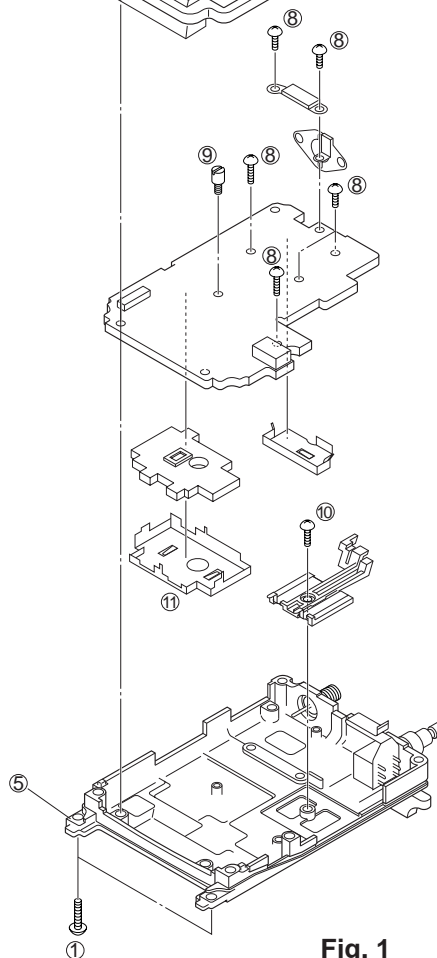

Fig. 1

DISASSEMBLY FOR REPAIR

3. Soldering the Bar antenna wires

Before soldering the bar antenna wires, form the wires as shown in the figure 2.
Then solder the wires to lands on the PCB.

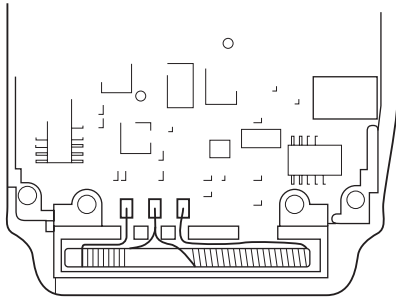

Fig. 2

5. Assembling a release latch

Place a coil spring(①) on the release latch(②) as shown in the figure 4.
Then insert a shaft(③) into the release latch.
Push the above assembly into the rear panel while the end of coil spring is hooked to the "A" tab.

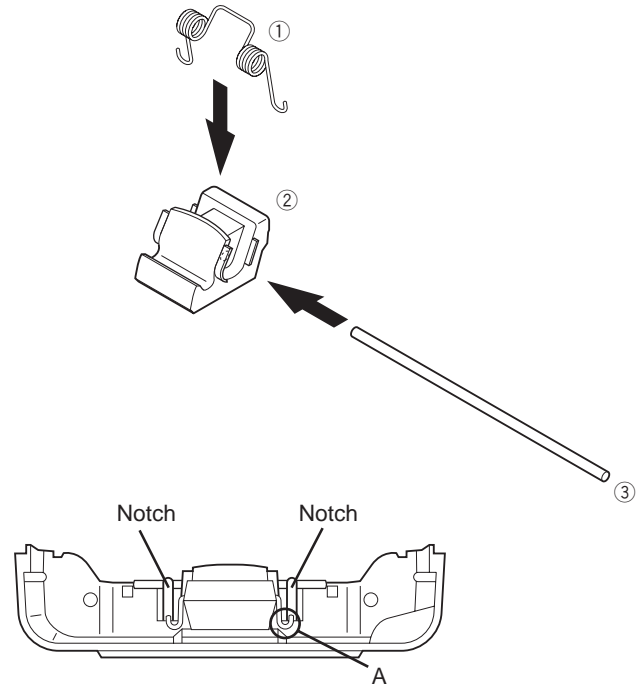

Fig. 4

4. Removing a relay terminal

Insert a screw driver between the relay terminal and its holder.
Then pull the relay terminal as shown in the figure 3.

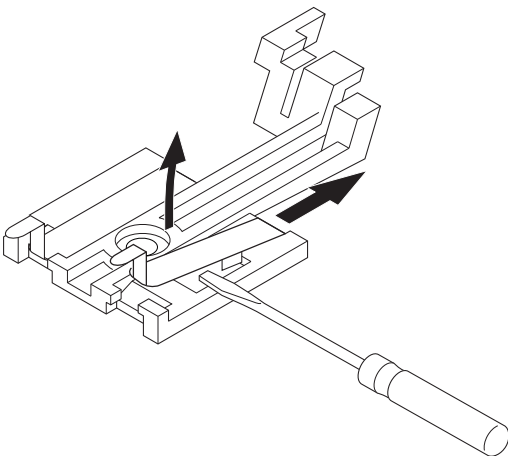

Fig. 3

6. Caution at the time of reassembling

While you are reassembling the battery terminal holder (J19-5428) and the packing (G53-1532), confirm that the packing is reassembled at the condition that any swell is not occurred on it. If the packing is assembled with any swell, width of body also becomes expansive.

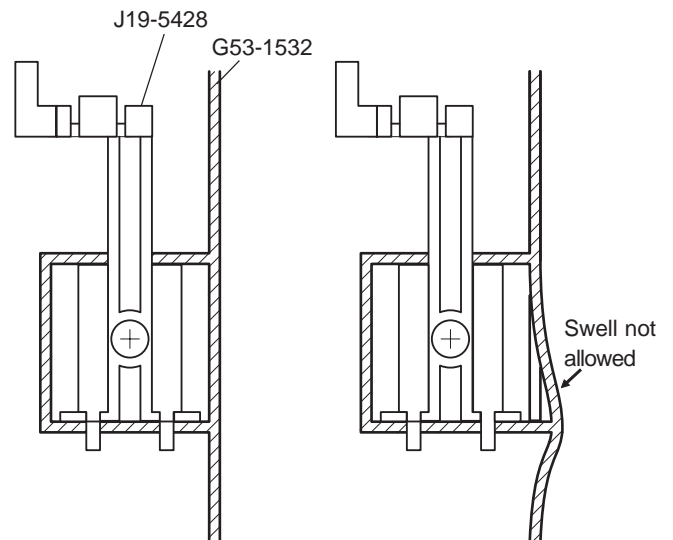

Fig. 5

CIRCUIT DESCRIPTION

1. A band receiver system

1-1. Receiver circuit

The A band can receive signals in two bands: VHF (220 MHz band <K type only>) and UHF (K type: three bands). It uses FM receive mode only, and uses double conversion with the first IF of 59.85 MHz and the second IF of 450 kHz.

The first amplifier is divided into two bands: 137 MHz - 173.995 MHz (216 MHz - 260 MHz <K type only>) and 410 MHz - 470 MHz. The incoming signal from the antenna passes through a low-pass filter and a duplexer, and goes to an independent amplifier (Q63, Q62) for each band.

1-1-1. VHF band frontend

The incoming signal from the antenna passes through a VHF band low-pass filter and a duplexer, passes through a band-pass filter where it is tuned with varicaps (D76, D77), and goes to the first amplifier (Q63). Unwanted signal components are eliminated by a two-pole band-pass filter where it is tuned by varicaps (D72, D75, D81, D83), and the signal goes to the common mixer (Q45) for the A band. (K type only: For 200MHz band reception, D74 is turned off with a control signal to improve band-pass filter coupling and ensure pass bandwidth.)

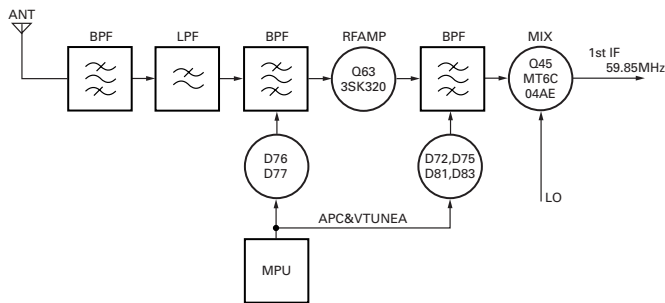

Fig.1

1-1-2. UHF band frontend

The incoming signal from the antenna passes through a UHF band low-pass filter and enters the first amplifier (Q62) common to both A and B bands. The amplified signal is distributed by L distributors (L95, L96) and goes to the LC filter module (L92). Unwanted signal components are eliminated by the filter, and the resulting signal passes through another band-pass filter and enters the mixer (Q45).

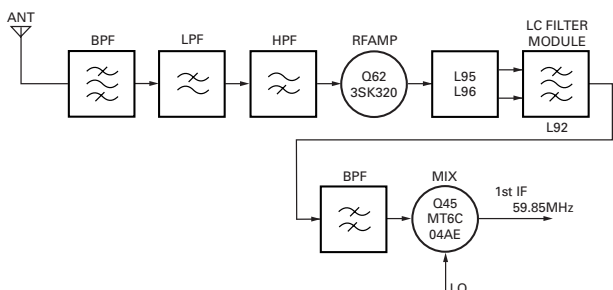

Fig.2

1-1-3. Circuits following IF

The signal heterodyned to the first IF of 59.85 MHz by the mixer (Q45) passes through a 15kHz MCF (XF2) and unwanted signal components are eliminated. The resulting signal is amplified by the IF amplifier (Q43) and goes to the FM IC (IC7). The FM IC heterodynes it to the second IF of 450 kHz. Then, the signal passes through a 15kHz external ceramic filter (CF4) and goes to the FM IC again. The signal amplified by the IF amplifier built into the IC is demodulated by the quadrature FM demodulation circuit using a discriminator (CD1) and converted into an audio signal and output.

The FM modulation signal output from the FM IC passes through a low-pass filter consisting of a resistor and a capacitor and is output to the control section. The demodulation signal input to the control section goes to the electronic volume (IC706, pin 13) to adjust the audio balance with the B band. The output signal is amplified by the operational amplifier (IC717), passes through an active filter consisting of Q719 and Q717, and goes to the audio amplifier (IC707). The signal amplified to a higher power by the audio amplifier becomes the final output signal from the set and output through the internal speaker or speaker output pin (J701).

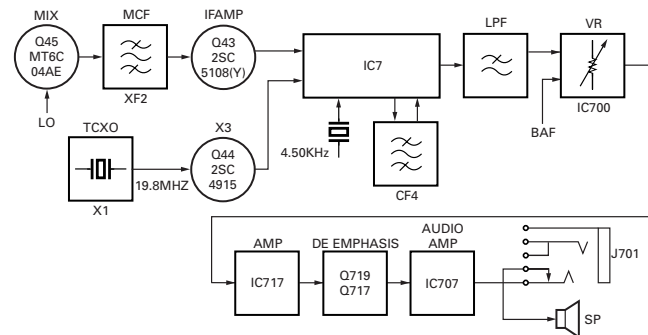

Fig.3

1-2. Mixer local oscillator

1-2-1. First mixer

The local oscillator signal for the first mixer is supplied from the VCO-PLL circuit.

1-2-2. Second mixer

The local oscillator signal for the second mixer is a 59.4 MHz signal that is produced by multiplying the 19.8MHz TCXO (X1) oscillator output with a multiplier (Q44).

2. B band receiver system

2-1. Receiver circuit

The B band has a broadband receiver circuit configuration and implements broadband reception of 100 kHz to 1.3 GHz. FM/AM/SSB/CW reception is possible in the range 100 kHz to 29.7 MHz, and FM/wide FM/AM/SSB/CW reception is possible in the range 29.7 MHz to 1.3 GHz. The FM/AM receiver circuit uses double conversion with the first IF of 57.6 MHz and the second IF of 450 kHz. The SSB/CW receiver circuit uses triple conversion with the first IF of 57.6 MHz and the second IF of 450 kHz. The wide FM receiver circuit uses single conversion with the IF of 10.8 MHz.

CIRCUIT DESCRIPTION

The first amplifier is divided into four bands: 100 kHz - 50 MHz, 50MHz - 108MHz, 108 MHz - 265 MHz, 265 MHz - 600 MHz, and 600 MHz - 1.3 GHz. The incoming signal from the antenna passes through a low-pass filter and a duplexer, and goes to an independent amplifier for each band. Then, the signal goes to the second common broadband amplifier (IC10) and its output is fed to the mixer (Q28) and heterodowned to the first IF.

2-1-1. FM/AM receiver circuit

The signal heterodowned to the first IF of 57.6MHz passes through a 15kHz MCF (XF1), and unwanted signal components are eliminated. The resulting signal is amplified by the IF amplifier (Q26) and goes to the FM IC (IC5). The FM IC heterodowns it to the second IF of 450 kHz. In FM mode, the signal passes through a 12.0kHz external ceramic filter (CF3) and goes to the FM IC. The signal amplified by the internal IF amplifier is demodulated by the quadrature FM demodulation circuit using a coil (L19) and converted into an audio signal and output. In AM mode, the signal passes through a 4kHz external ceramic filter CF1 and goes back to the FM IC. It is amplified by the AM AGC amplifier built in the FM IC, an audio

signal demodulated by the diode detection circuit is output.

2-1-2. SSB/CW receiver circuit

In SSB/CW mode reception, the signal takes the same path to CF1 as in AM mode. The signal input to the FM IC again is amplified by the AM AGC amplifier in the FM IC, then output from the AM IF output pin. The signal is fed to the third mixer (IC4) and converted to an audio signal and output.

2-1-3. Wide FM receiver circuit

The signal converted to the first IF of 10.8 MHz passes through a ceramic filter CF5 for wide FM, and is amplified by the IF amplifier (Q24). The signal passes through ceramic filter CF2 again to eliminate unwanted signal components, and goes to the FM IF input (pin 7) of the FM IC. The input signal is amplified by the IF amplifier in the IC, demodulated by the quadrature FM demodulation circuit using an L18 coil, and

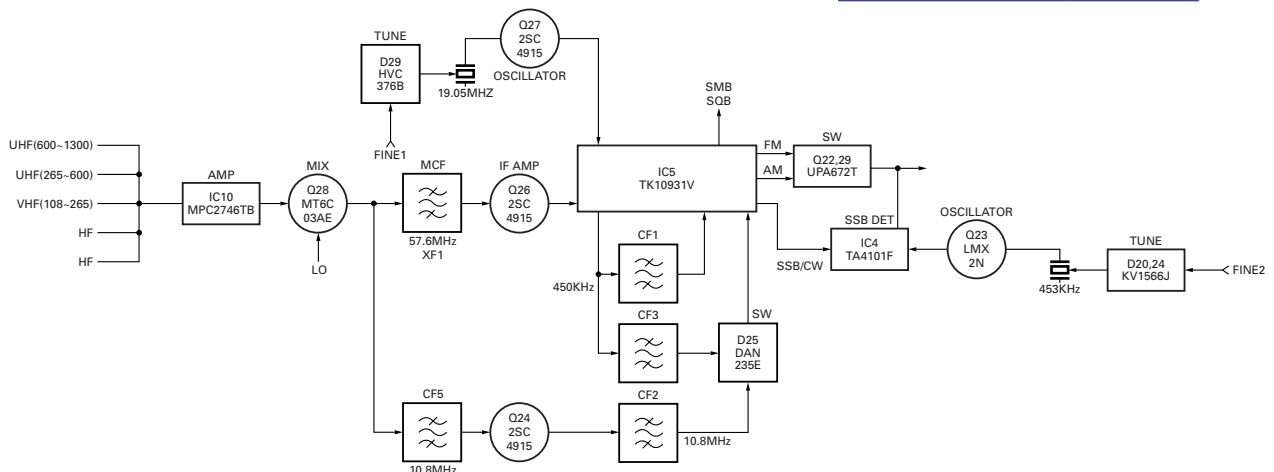

Fig.4

output from the FM IC as an audio signal.

2-1-4. AM bar antenna receiver circuit

This unit incorporates an AM bar antenna, and either the bar antenna or the supplied antenna can be selected in the 520kHz-1.8MHz (SW) and 3.5MHz-10.1MHz (MW) bands (the initial value: bar antenna). The bar antenna has two kinds of tuners for SW and MW tuning, one of which is selected with a switching FET (Q32, Q48, Q52). The antenna is tuned with a varicap (D60) for AM tuning to select a desired signal. The signal from the bar antenna is amplified by and its impedance is converted by the buffer amplifier (Q59), and the resulting signal goes to the common mixer (Q28) for the B band. The signal is routed over the same path for AM demodulation as for the supplied antenna after leaving the mixer.

2-1-5. Audio signal

The FM and AM demodulation signals output from the FM IC (IC5) pass through a low-pass filter consisting of a resistor and a capacitor, and goes to the switching FET (Q29), from which a switched signal is output to the control unit. The SSB/CW demodulation signal passes through an RC LPF, connects to the Q29 output section, and output to the control unit through a line common to all modes. The demodulation signal input to the control unit goes to the electronic volume (IC706, pin 16), the audio balance output with the A band is restricted, then the signal is output. It joins the A band demodulation signal and is processed in the same manner for both A and B bands.

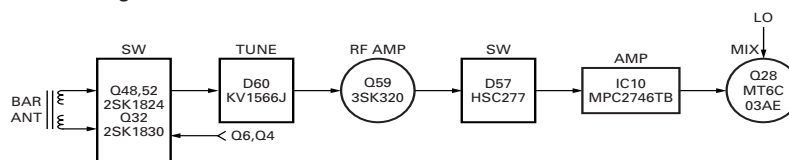

Fig.5

CIRCUIT DESCRIPTION

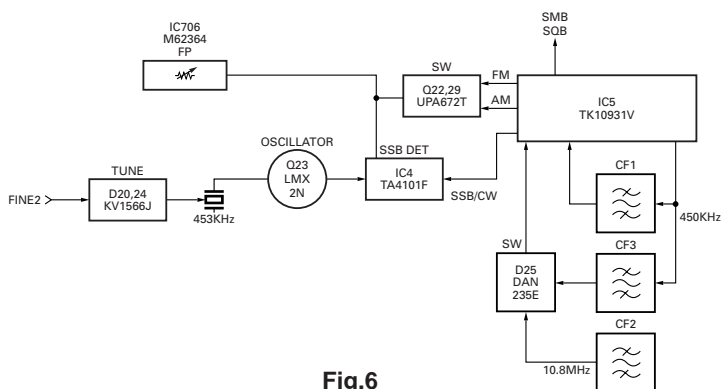

Fig.6

2-2. Mixer local oscillator

2-2-1. First mixer

The local oscillator signal for the first mixer is supplied from the VCO-PLL circuit. To offset according to modes, the PLL switching frequency changes in FM/AM/CW, USB, LSB.

1st LOCAL (PLL Switching Frequency)

	FM/AM	CW	USB	LSB
UPPER	Per 5kHz	FM-2.5kHz	FM-4.5kHz	FM-0.5kHz
LOWER	Per 5kHz	FM-2.5kHz	FM-4.5kHz	FM-0.5kHz

* PLL Switching Frequency changes with the modes.

Table.1

2-2-2. Second mixer

The local oscillator signal of the second mixer uses 57.15MHz which is three times as high as the 19.05MHz crystal oscillator (X3) output. This local oscillator signal is used to (i) implement fine steps during fine tuning and (ii) offset during SSB/CW reception.

2nd LOCAL (Oscillator Frequency)

	FM/AM	CW(Fine Tuning)	USB(Fine Tuning)	LSB(Fine Tuning)
UPPER	57.15MHz	57.15MHz+2.5kHz	57.15MHz-2.5kHz	57.15MHz-2.5kHz
LOWER	57.15MHz	Oscillator Frequency 57.15MHz-2.5kHz	57.15MHz+2.5kHz	57.15MHz+2.5kHz

PLL Switching Frequency

* During fine tuning, it changes with 33.3 Hz step from PLL Switching Frequency to the next Switching Frequency.

Table.2

(i) Fine tuning function

When the fine tuning function is ON, the PLL comparison frequency is 5 kHz (5kHz step). The "receive frequency of 10Hz steps as a set" is implemented by operating the local oscillator signal of the second mixer in 33.3Hz steps in the 5kHz frequency range. The frequency is varied by 57.15 MHz +/- 2.5 kHz by changing the voltage applied to the varicap (D29) installed in the local oscillator circuit.

(ii) Mode offset

The IF frequency is adjusted by 2 Hz in SSB mode so that the demodulated signal passes through the center of the 4kHz ceramic filter (CF1). The frequency is adjusted by varying the local oscillator frequency.

2-2-3. Third mixer

The third mixer (IC4) works in SSB/CW mode only. The local oscillator signal of 450 kHz +/- 2 kHz is produced in SSB mode to restore 2kHz correction (offset), and the signal of 450 kHz - 800 Hz is produced to generate an 800Hz beat frequency in CW mode. A demodulation signal is produced in SSB, and a 800Hz beat signal is produced in CW.

3rd LOCAL (Oscillator Frequency)

	FM/AM	CW	USB	LSB
UPPER	450kHz	450kHz+800Hz	450kHz+2kHz	450kHz-2kHz
LOWER	450kHz	450kHz+800Hz	450kHz-2kHz	450kHz+2kHz

* Perform Mode OFFSET

Table.3

2-3. AGC circuit

The AGC is controlled by using the output from the RF AGC built into the FM IC (IC5). The AGC is controlled by controlling the bias current of the IF amplifier (Q26) and the forward current of the pin diode (D32) for the attenuator. In non-FM mode, the AM AGC circuit built-into the FM IC is also used.

3. Control

3-1. Reset and backup circuits

The CPU reset signal is generated with the CR time constant by detecting a rising edge of the M4 line voltage with the voltage detection IC (IC709). If the voltage supplied to the TH-F6/TH-F7 decreases and the M4 line voltage falls below the detection voltage of the voltage detection IC (IC710), the CPU (IC705) detects it through the interrupt pin, backs up data in the EEPROM (IC704), and shuts the power off.

3-2. Voltage detection processing

The voltages are measured through the A/D port of the CPU (IC705) for processing. The battery voltage is supplied through a resistor, and a warning sound is produced when an abnormal power supply voltage (17.5 to 22.0 V) is applied to the battery meter during transmission. The squelch voltage is input from the IF IC, and a change in the noise voltage is detected to control squelch. The S meter voltage is input from the IF IC to control the S meter display. Thermistor voltage (temperature) detection, remote control microphone key operation, VOX voltage monitoring, and TONE/DCS decoding are performed through the A/D port.

3-3. VOX

The signal output from the microphone amplifier (IC702) is amplified by Q701, rectified/integrated by D709 to convert to DC voltage, and monitored through the A/D port of the CPU (IC705) to perform VOX processing.

3-4. Battery save

The CPU (IC705) controls Q728 through the SAVE port to save battery power.

3-5. LED drive circuit

The CPU (IC705) controls Q709 to turn LEDs on to illuminate the LCD and keys. The ON AIR/BUSY LED is directly controlled through the open drain port of the CPU (IC705).

CIRCUIT DESCRIPTION

3-6. Key/encoder input circuit

The PWR key is assigned to an interrupt port. The PTT key is assigned to another interrupt port. The other keys and destination diodes form a 5x6 matrix and pressing a key is detected by scanning the matrix by software. The encoder reads data through the interrupt port.

3-7. CTCSS/DCS

The encode signal is output from the D/A port of the CPU (IC705) by software. The signal level is adjusted with an electronic VR (IC706) and the signal is divided into VCO and TCXO and modulated like a 9600bps packet signal.

The audio signal from the IF IC passes through the IC712/IC711 waveform rectification circuit and enters the A/D port of the CPU (IC705). The CPU detects that the specified CTCSS tone frequency and DCS code are detected and controls muting.

3-8. DTMF

The DTMF signal is output from the D/A port of the CPU (IC705) by software means. The signal is mixed with a signal at the input side of the audio amplifier (IC707) and output as a monitor tone. It is mixed with a modulation signal at the input side of the preemphasis (IC701) and used to as a transmit signal.

3-9. Serial control

The REM/PTT terminal of the speaker mic jack (J701) is switched by the CPU (IC705) and functions as TXT/RXD to communicate with a personal computer.

4. PLL • VCO

The TH-F6/TH-F7 has two PLL loops and a total of four VCOs, two for each PLL loop. The PLL is divided for A band reception, B band reception and transmission. Each VCO has oscillator frequency shift control. For relationships between VCO oscillator frequencies and shifts, see Table 4-11.

TH-F6A Frequency Construction
A band RX Double Super Heterodyne

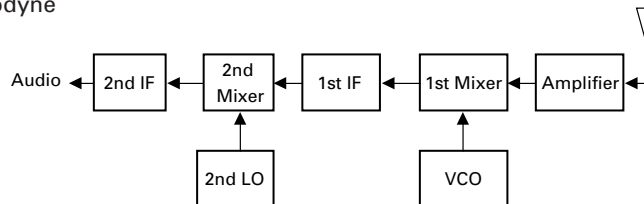

Fig.7

RX Freq. Range [MHz]		VCO Oscillation [MHz]		1st Mix.	1st IF [MHz]	2nd LO [MHz]	2nd Mix.	2nd IF [kHz]
137.000	173.995	196.850	233.845	Upper	59.85	59.4	Lower	450
216.000	259.995	275.850	319.845	Upper	59.85	59.4	Lower	450
410.000	469.995	350.150	410.145	Lower	59.85	59.4	Lower	450

Table.4

TH-F6A Frequency Construction
TX

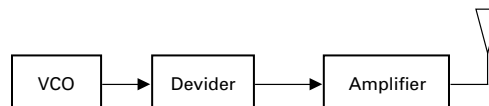

Fig.8

Band [MHz]	Transmission Frequency Range [MHz]		VCO Oscillation [MHz]		Divide
144	144.000	147.995	576.000	591.980	4
220	222.000	224.995	444.000	449.990	2
440	438.000	449.995	438.000	449.995	1

Table.5

TH-F6A/F7E

CIRCUIT DESCRIPTION

* TH-F6A Frequency Construction
B band RX FM mode Double Super Heterodyne

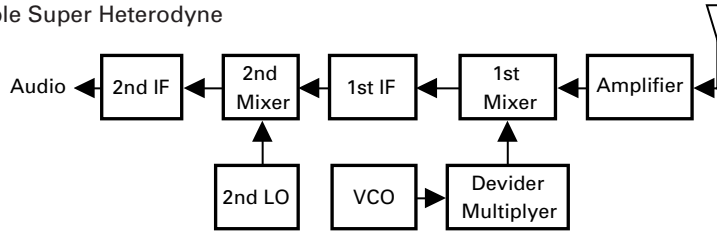

Fig.9

RX Freq. Range [MHz]		VCO Oscillation [MHz]		Multiply	Devide	1st LO		1st Mix.	1st IF [MHz]	2nd LO [MHz]	2nd Mix.	2nd IF [kHz]
0.100	22.995	461.600	644.760	1	8	57.700	80.595	Upper	57.6	57.15	Lower	450
23.000	103.995	322.400	646.380	1	4	80.600	161.595	Upper	57.6	57.15	Lower	450
104.000	266.995	323.200	649.190	1	2	161.600	324.595	Upper	57.6	57.15	Lower	450
267.000	409.995	324.600	647.595	1	1	324.600	647.595	Upper	57.6	57.15	Lower	450
410.000	469.995	352.400	412.395	1	1	352.400	412.395	Lower	57.6	57.15	Lower	450
470.000	591.995	527.600	649.595	1	1	527.600	649.595	Upper	57.6	57.15	Lower	450
592.000	706.995	534.400	649.395	1	1	534.400	649.395	Lower	57.6	57.15	Lower	450
707.000	707.995	382.300	382.798	2	1	764.600	765.595	Upper	57.6	57.15	Lower	450
708.000	851.995	325.200	397.198	2	1	650.400	794.395	Lower	57.6	57.15	Lower	450
852.000	868.995	454.800	463.298	2	1	909.600	926.595	Upper	57.6	57.15	Lower	450
869.000	896.995	405.700	419.698	2	1	811.400	839.395	Lower	57.6	57.15	Lower	450
897.000	922.995	477.300	490.298	2	1	954.600	980.595	Upper	57.6	57.15	Lower	450
923.000	938.995	432.700	440.698	2	1	865.400	881.395	Lower	57.6	57.15	Lower	450
939.000	1009.995	498.300	533.798	2	1	996.600	1067.595	Upper	57.6	57.15	Lower	450
1010.000	1299.995	476.200	621.198	2	1	952.400	1242.395	Lower	57.6	57.15	Lower	450

Table.6

B band RX WFM mode Single Super Heterodyne

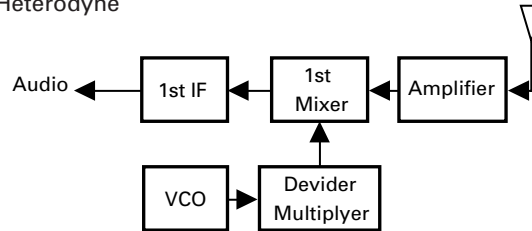

Fig.10

RX Freq. Range [MHz]		VCO Oscillation [MHz]		Multiply	Devide	1st LO		1st Mix.	1st IF [MHz]
29.700	54.995	324.000	526.360	1	8	40.500	65.795	Upper	10.8
55.000	91.995	353.600	649.560	1	8	44.200	81.195	Lower	10.8
92.000	130.795	324.800	479.980	1	4	81.200	119.995	Lower	10.8
130.800	150.995	566.400	647.180	1	4	141.600	161.795	Upper	10.8
151.000	309.995	323.600	641.590	1	2	161.800	320.795	Upper	10.8
310.000	449.995	320.800	460.795	1	1	320.800	460.795	Upper	10.8
450.000	659.995	439.200	649.195	1	1	439.200	649.195	Lower	10.8
660.000	1299.995	324.600	644.598	2	1	649.200	1289.195	Lower	10.8

Table.7

CIRCUIT DESCRIPTION

* TH-F7 Frequency Construction
 A band RX Double Super Heterodyne

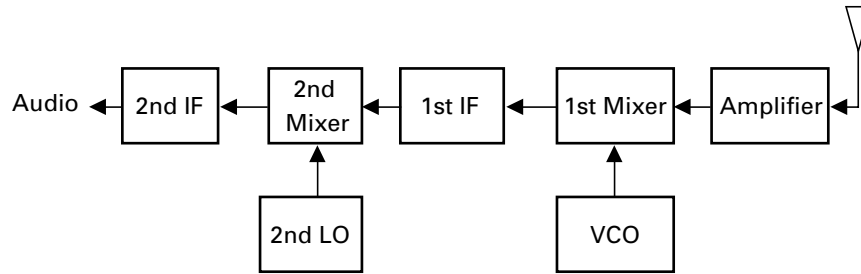

Fig.11

RX Freq. Range [MHz]		VCO Oscillation [MHz]		1st Mix.	1st IF [MHz]	2nd LO [MHz]	2nd Mix.	2nd IF [kHz]
144.000	145.995	203.850	205.845	Upper	59.85	59.4	Lower	450
430.000	439.995	370.150	380.145	Lower	59.85	59.4	Lower	450

Table.8

TH-F7 Frequency Construction

Fig.12

Band [MHz]	Transmission Frequency Range [MHz]		VCO Oscillation [MHz]		Divide
144	144.000	145.995	576.000	583.980	4
440	430.000	439.995	430.000	439.995	1

Table.9

TH-F6A/F7E

CIRCUIT DESCRIPTION

* TH-F7 Frequency Construction
B band RX FM mode Double Super Heterodyne

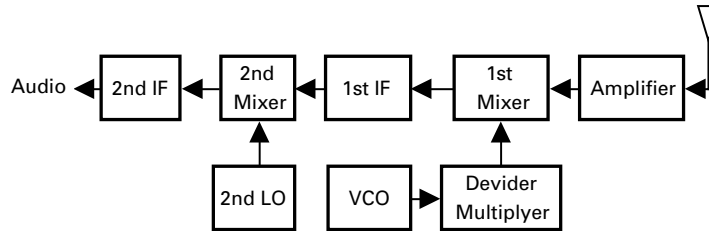

Fig.13

RX Freq. Range [MHz]		VCO Oscillation [MHz]		Multiply	Divide	1st LO		1st Mix.	1st IF [MHz]	2nd LO [MHz]	2nd Mix.	2nd IF [kHz]
0.100	22.995	461.600	644.760	1	8	57.700	80.595	Upper	57.6	57.15	Lower	450
23.000	103.995	322.400	646.380	1	4	80.600	161.595	Upper	57.6	57.15	Lower	450
104.000	266.995	323.200	649.190	1	2	161.600	324.595	Upper	57.6	57.15	Lower	450
267.000	409.995	324.600	647.595	1	1	324.600	467.595	Upper	57.6	57.15	Lower	450
410.000	469.995	352.400	412.395	1	1	352.400	412.395	Lower	57.6	57.15	Lower	450
470.000	591.995	527.600	649.595	1	1	527.600	649.595	Upper	57.6	57.15	Lower	450
592.000	706.995	534.400	649.395	1	1	534.400	649.395	Lower	57.6	57.15	Lower	450
707.000	707.995	382.300	382.798	2	1	764.600	765.595	Upper	57.6	57.15	Lower	450
708.000	851.995	325.200	397.198	2	1	650.400	794.395	Lower	57.6	57.15	Lower	450
852.000	868.995	454.800	463.298	2	1	909.600	926.595	Upper	57.6	57.15	Lower	450
869.000	896.995	405.700	419.698	2	1	811.400	839.395	Lower	57.6	57.15	Lower	450
897.000	922.995	477.300	490.298	2	1	954.600	980.595	Upper	57.6	57.15	Lower	450
923.000	938.995	432.700	440.698	2	1	865.400	881.395	Lower	57.6	57.15	Lower	450
939.000	1009.995	498.300	533.798	2	1	996.600	1067.595	Upper	57.6	57.15	Lower	450
1010.000	1299.995	476.200	621.198	2	1	952.400	1242.395	Lower	57.6	57.15	Lower	450

Table.10

B band RX WFM mode Single Super Heterodyne

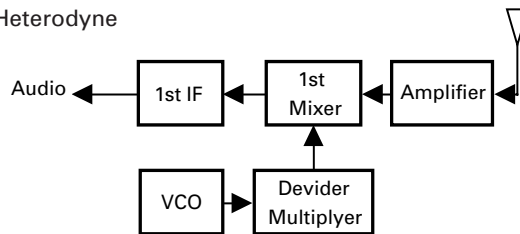

Fig.14

RX Freq. Range [MHz]		VCO Oscillation [MHz]		Multiply	Divide	1st LO		1st Mix.	1st IF [MHz]
29.700	54.995	324.000	526.360	1	8	40.500	65.795	Upper	10.8
55.000	91.995	353.600	649.560	1	8	44.200	81.195	Lower	10.8
92.000	130.795	324.800	479.980	1	4	81.200	119.995	Lower	10.8
130.800	150.995	566.400	647.180	1	4	141.600	161.795	Upper	10.8
151.000	309.995	323.600	641.590	1	2	161.800	320.795	Upper	10.8
310.000	449.995	320.800	460.795	1	1	320.800	460.795	Upper	10.8
450.000	659.995	439.200	649.195	1	1	439.200	649.195	Lower	10.8
660.000	1299.995	324.600	644.598	2	1	649.200	1289.195	Lower	10.8

Table.11

CIRCUIT DESCRIPTION

4-1. A band reception

IC6 functions as A band reception PLL. This PLL IC controls the VCO produced by Q34. VCOs are changed over by switching the power provided to each VCO by Q35 through control line "DAVCOS" from the CPU. VCO power passes through a ripple filter consisting of Q31 and C235.

Each VCO output is amplified by a common amplifier Q37. In VHF/UHF band reception, the signal passes through a low-pass filter, is amplified by Q40, then by a common local amplifier (Q41), and goes to a mixer. This low-pass filter uses a varicap (D28, D106) to shift cut-off frequency. The FIN input to the PLL IC is taken from the Q40 output.

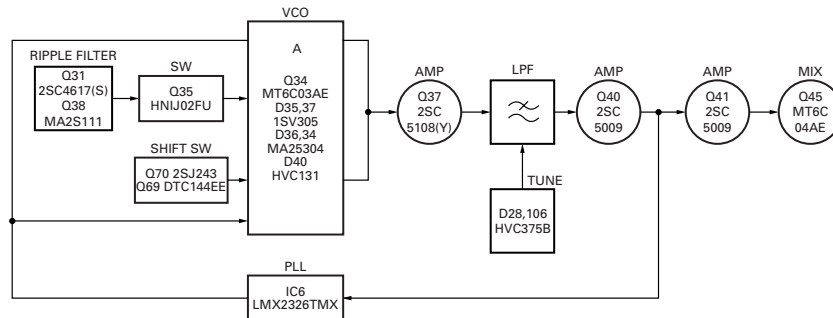

Fig.15

4-2. B band reception and transmission

IC2 functions as B band reception PLL. This PLL IC controls the VCO produced by Q9. VCOs are changed over by switching the power supplied to each VCO by Q10 through control line "DBSS" from the CPU. VCO power passes through a ripple filter consisting of Q7 and C52. Each VCO output is amplified by a common amplifier (Q13).

4-2-2. 267MHz-707MHz reception, UHF transmission

The Q13 output goes to the mixer during reception and to the drive during transmission. The PLL IC FIN input is generated by extracting the output from Q13 and amplifying it with an amplifier (Q11).

4-2-1. 0.1MHz-267MHz reception, VHF (220MHz <K type only>) band transmission

The VCO oscillator frequency is UHF. The signal output from Q13 goes to the prescaler IC (IC3) and is divided into 1/8 (0.1MHz-23MHz), 1/4 (23MHz-104MHz), and 1/2 (104MHz-267MHz). Division is controlled by using control signals "SW1 (Q15)" and "SW2 (Q15)" from the CPU. The division output is amplified by an amplifier (Q19), and the signal goes to the mixer (Q28) during reception and to the drive during transmission. The PLL IC FIN input is generated by extracting the output from Q13 and amplifying it with an amplifier (Q11).

4-2-3. 707MHz-1.3GHz reception

Output signal from Q13 is amplified by an amplifier (Q11), then the signal is multiplied by 2 by a multiplier (Q12). The signal is then amplified with three amplifiers (Q21), and goes to the mixer (Q28) during reception and to the drive (Q71) during transmission. The FIN input of the PLL IC (IC2) is input by taking the output from Q11.

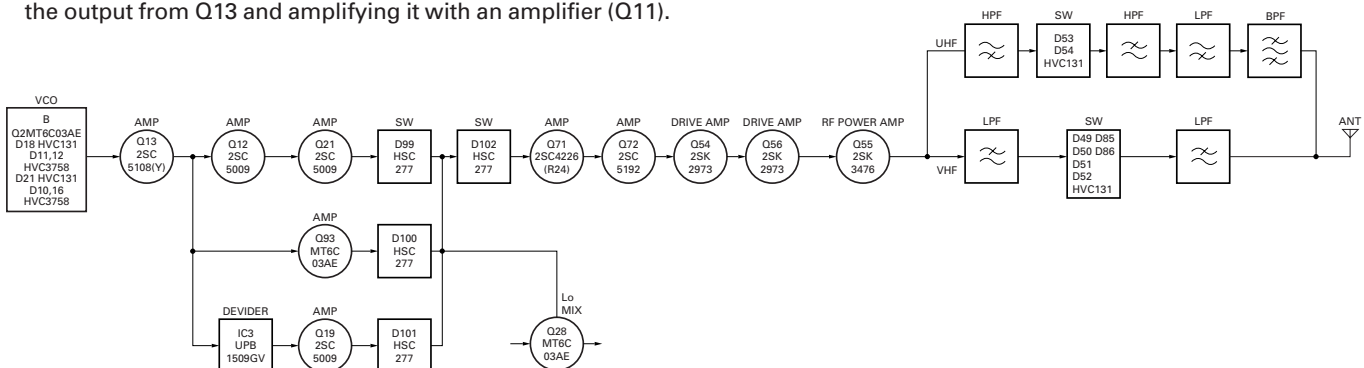

Fig.16

CIRCUIT DESCRIPTION

5. Lithium ion battery charging control

If a lithium ion battery is installed, it is charged when power is supplied to the DCIN JACK from outside. The mechanism of charging control is described below.

When power is provided to the DCIN JACK, Q65 turns ON and the control port is made LOW to notify the CPU of connection of an external power source. The CPU grounds the Q2 collector according to this information. As a result, Q5 turns OFF and Q1 turns ON. If the remaining battery level is low, the Q1 collector current increases, so the emitter voltage is reduced by R2 and Q2 turns ON to charge the battery (charging). The CPU pulls up the Q2 collector voltage, uses this port as input, and monitors it. If the battery voltage level increases, the Q1 collector current decreases, the emitter voltage drops and Q2 turns OFF at a certain voltage. The CPU recognizes that charging is approaching its end by this change, and enters an additional charging state. In the additional charging state, the CPU grounds the Q2 collector and continues charging slowly in about an hour. When it ends, the battery charging is complete.

IC1 is a lithium ion battery charge control IC. When the battery voltage exceeds 8.4 V, the output port is made HIGH and Q3 is turned OFF to stop charging. If it is 8.4 V or lower, "LOW" is output and Q3 is turned ON to bias Q1.

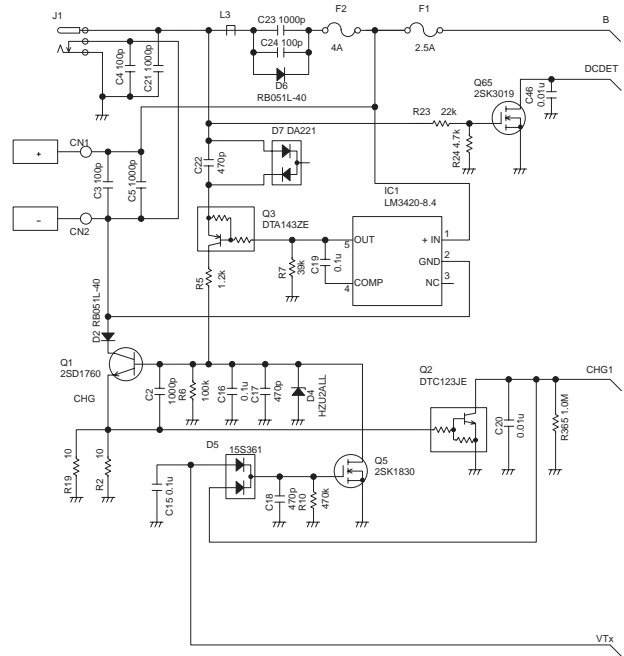

Fig.17

6. Receive audio circuit

The receive signal demodulated by the FM IC on each of the A and B bands passes through an electronic volume (IC706) and is amplified by IC717. The signal is deemphasized by Q719, passes through a variable RESISTOR (AFVR), is amplified by the audio amplifier (IC707), and output to the speaker (SP1) or external speaker jack (J701).

CTCSS or DCS is a 2-channel multiplexer from FM IC output, and A or B band is selected, the signal passes through an amplifier filter (IC711), and goes to the CPU where it is decoded.

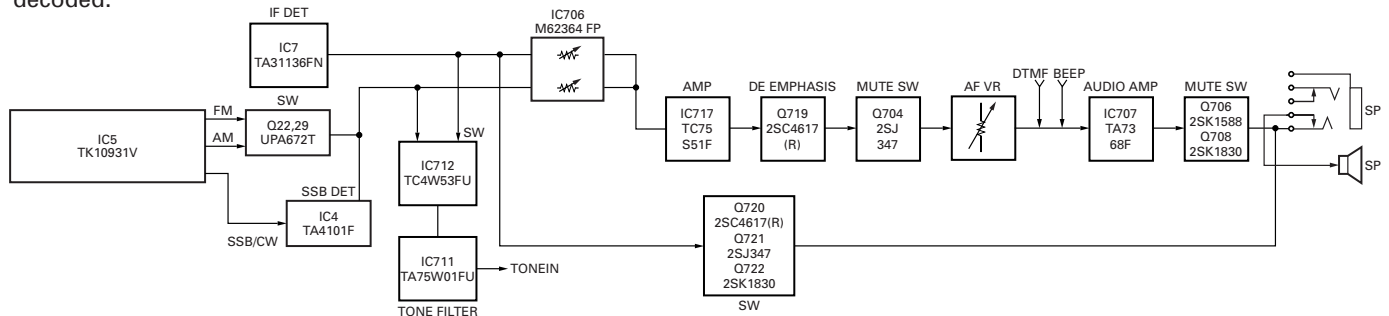

Fig.18

7. Transmission signal system

7-1. Modulation circuit

The audio modulation input is switched between external input and internal microphone using an external microphone terminal, and its base band is processed by microphone amplifier IC 702 and preemphasis/limiter IC 701. The signal is mixed with a DTMF subtone before the preemphasis circuit, the level is adjusted by electronic VR IC706, and the signal is input to the VCO as a modulation signal. The excessive input of the 9600bps packet signal and the high-speed FM mode

The 9600bps packet signal is produced by converting the impedance of the output signal from the FM IC by Q720 and Q721, passing it through the Q722 switch, and outputting it to the speaker (SP1) or external speaker jack (J701).

SSTV transmit signal input through the external microphone input terminal is suppressed by D710 and D711, switched by IC703, and input to electronic VR IC706. The level-adjusted signal is amplified by Q719, passes through electronic VR IC706, and is divided into two paths: one for modulating the VCO through electronic VR IC706 the other for modulating TCXO X1 through amplifier IC702 to perform broadband transmission modulation.

CIRCUIT DESCRIPTION

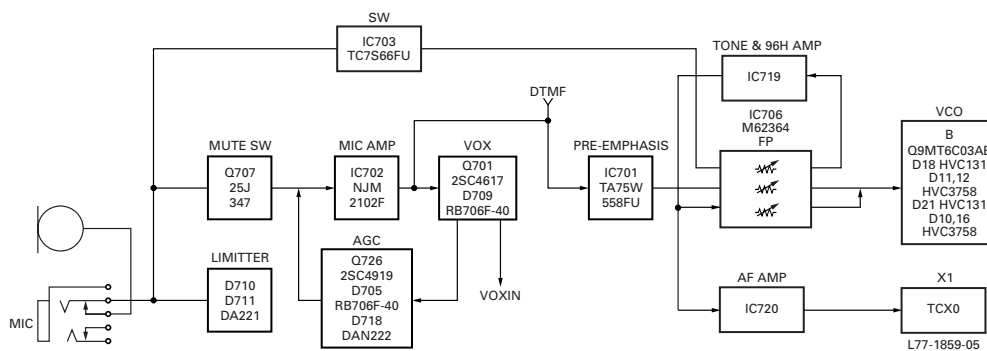

Fig.19

7-2. Transmission circuit

For the VHF VCO output, the 500MHz output passes through the RF amplifier (Q13), is divided into 1/4 and amplified by Q19. The signal passes through switch D101/D102, is amplified by four amplifiers Q71, Q72, Q54, and Q56, and amplified to the final output by power amplifier Q55. The signal passes through a low-pass filter, an antenna switch, and another low-pass filter, and is sent to the antenna.

[(K only) The 220MHz VCO output is produced by passing the 400MHz output through the RF amplifier (Q13), dividing it into 1/2 by IC3, and amplifying it by Q19. The signal passes through a switch (D101/D102), is amplified by four amplifiers Q71/Q72/Q54/Q56, and amplified to the final output by power amplifier Q57. The signal passes through a low-pass filter, an antenna switch, and another low-pass filter, and is supplied to the antenna.]

The UHF VCO output is directly produced, passes through RF amplifier Q13, and is amplified by Q93. It passes through switch D100/D102, is amplified by four amplifiers Q71/Q72/Q54/Q56, and amplified to the final output by power amplifier Q55. It passes through a high-pass filter, an antenna switch, and an antenna filter, and goes to the antenna.

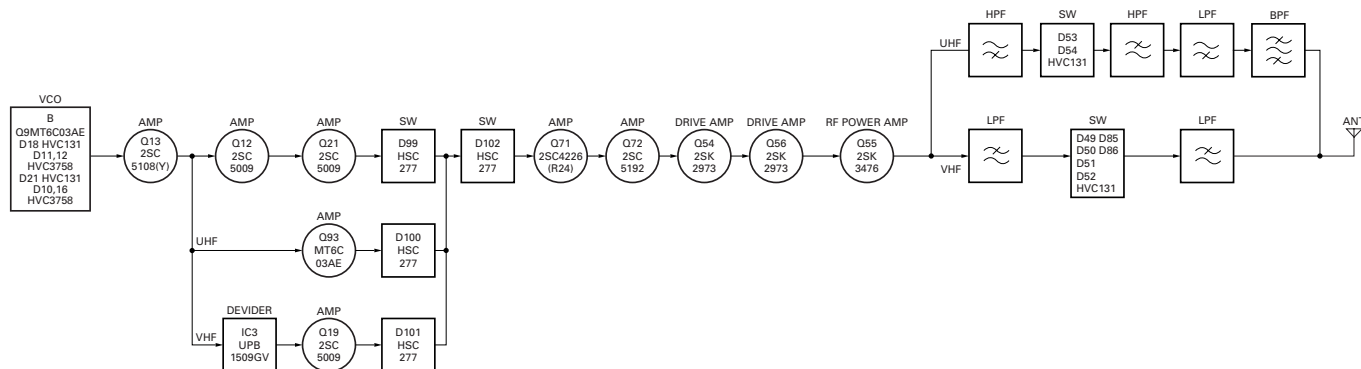

Fig.20

7-3. APC circuit

The APC circuit is used to provide stable transmission output, detects drain current of the power module and controls transmission output. The voltage produced at R204, and R206 is amplified by IC8 and Q50, and the difference between the voltage and the reference voltage of each band/power output from the CPU (IC705) is detected by IC9 to produce APC voltage. This voltage controls the gain of Q54, Q56, Q55, and Q57.

7-4. Temperature protection circuit

To prevent thermal destruction of the final power amplifier, the voltage of the thermistor TH1 installed near the power module is monitored by the CPU IC705. If the prescribed temperature is exceeded, the APC voltage is decreased to reduce heat generation.

TH-F6A/F7E

DESCRIPTION OF COMPONENTS

● (X14-6750-00)

Ref. No.	DESCRIPTION NAME	Use/function
IC1	Charge IC	
IC2	PLL IC	B band RX TX
IC3	PRESCALER	divided into 1/2, 1/4, and 1/8
IC4	Mixer for SSB detection	
IC5	FM/AM IC	2nd mix, quadrature detection, AF output, noise amp output, S-meter
IC6	PLL IC	for A band receiver
IC7	FM IC	2nd mix, quadrature detection, AF output, noise amp output, S-meter
IC8	APC Control	Transmission APC control OP-AMP
IC9	APC Control	Transmission APC control OP-AMP
IC10	Wide band AMP	B band receiver 2nd amp
IC11	Shift register	Shift register (ATT, power supply, ANT SW,)
IC701	MIC&DTMF AMP	Limiter amp, splatter filter
IC702	MIC AMP	
IC703	AMP for packet	
IC704	E2PROM	
IC705	CPU	for J, K, E type
IC706	Electronic VR	
IC707	AF AMP	
IC708	4.0 regulator	
IC709	RESET IC	
IC710	3.5V Detector	
IC711	TONE FILTER	CTCSS, ADCS
IC712	TONE DETECTOR	
IC713	DC · DC converter	
IC714	APC circuit	Transmitter
IC715	3.0 regulator	LCD booster Circuit
IC717	Rx AF AMP	
IC718	BPF Voltage adjust	B band RX TX
IC719	TONE&96H AMP	
IC720	AF AMP	
D1	voltage shift	Power supply voltage shift
D2	reverse current protector	reverse current protector
D4	Limiter	
D5	Charge IC	reverse current protector
D6	reverse current protector	reverse current protector
D7	voltage shift	voltage shift
D8	PLL Lock voltage detect SW	B band RX TX
D9	DC SW	Speed up SW
D10-12	VCO	VCO
D16	VCO	VCO
D18	VCO	VCO shift SW
D20	Tuning	SSB/CW 3rd LO oscillation frequency tuning
D21	VCO	VCO shift SW
D24	Tuning	SSB/CW 3rd LO oscillation frequency tuning
D25	RF SW	FM/W-FM SW
D28	Tuning	A band local filter tuning
D29	Tuning	2rd LO oscillation frequency tuning

Ref. No.	DESCRIPTION NAME	Use/function
D32	ATT	B band RF AGC ATT
D33	PLL Lock voltage detect SW	A band PLL IC power supply voltage shift
D34-37	VCO	VCO
D38	DC SW	Speed up SW
D40	RF SW	VCO shift SW
D41	RF SW	A band VCO output SW
D44	reverse current protector	
D45	Limiter	voltage limiter
D49	ANT SW	
D51-54	ANT SW	
D57	RF SW	Bar antenna RF receive line SW
D58	POWER SW	B band 2nd wide band amp power supply SW
D59	RF AMP SW	
D60	Tuning	Bar antenna frequency tuning
D62	ANT SW	
D63	reverse current protector	
D65	RF SW	B band RF receive line SW 600 to 1300MHz
D67	RF SW	A band 265 to 680MHz
D68	RF SW	B band 265 to 680MHz
D69	UHF RF AMP SW	UHF 1st amp control
D70	ANT SW	
D71	RF SW	A band VHF (220MHz K type only)
D72	Tuning	A band VHF BPF tuning
D73	ANT SW	
D74	RF SW	220MHz band BPF tuning
D75-77	Tuning	A band VHF BPF tuning
D78	RF SW	B band 108 to 265MHz
D80	RF SW	B band 50 to 108MHz
D81	Tuning	A band VHF BPF tuning
D82	ANT SW	
D83	Tuning	A band VHF BPF tuning
D85	ANT SW	
D87-90	Tuning	B band VHF BPF tuning
D91	RF SW	B band 0.1 to 50MHz
D93	ANT SW	B band 50 to 105MHz
D94	ANT SW	B band 0.1 to 50MHz
D95-97	BPF tuning	B band 50 to 108MHz receive BPF tuning
D99	RF SW	B band local 650 to 1.3GHz
D100	RF SW	B band local 325 to 650MHz
D101	RF SW	B band local 0.1 to 325MHz
D102	RF SW	Transmission drive input SW
D103	SW	Matching SW
D104	ANT SW	
D106	Tuning	A band local filter tuning
D107-110	RF SW	B band PLL IC Fin filter SW
D112,113	ANT SW	Receiver circuit protector SW (ON:transmission)
D114	ANT SW	Transmission band SW

DESCRIPTION OF COMPONENTS

Ref. No.	DESCRIPTION NAME	Use/function
D115	RF SW	
D116	ATT SW	B band 50 to 108MHz ON:receive ATT on
D117,118	ANT SW	
D119	ANT SW	Q57 control SW
D120	ANT SW	Q55 control SW
D121	reverse current protector	
D122	voltage shift	
D123	overvoltage protector	
D124,125	overinput protector	
D126	voltage shift	
D702-704	Type setting diode	
D705	AF rectification	
D706-708	reverse current protector	
D709	AF rectification	
D710,711	overvoltage protector	
D712-717	LED	
D718	AGC SW	
D719	reverse current protector	
D720-725	LED	
D726	constant-voltage circuit	
D727	reverse current protector	
D730-732	reverse current protector	
Q1	constant-current circuit	constant current charge
Q2	Charge control	
Q3	Charge control	constant potential charge
Q4	SW	B band/transmission PLL charge pump SW
Q5	Charge control	
Q6	SW	B band/transmission PLL VCO shift SW
Q7	RIPPLE FILTER	B band/transmission VCO power supply
Q8	SW	Prescaler divider SW
Q9	OSCILLATOR	B band /transmission VCO
Q10	VCO power supply SW	
Q11	RF AMP	
Q12	RF AMP	
Q13	BUFFER AMP	
Q14	Power supply switch	Prescaler power supply SW
Q15	SW	Prescaler divider SW
Q17	SW	Prescaler divider SW
Q19	RF SW	B band local amp
Q21	RF AMP	B band local amp
Q22	AF SW	B band AF output SW
Q23	3rd local AMP	3rd local (crystal oscillator) buffer amp
Q24	IF AMP	B band W-FM
Q25	AGC AMP	B band IF AGC DC amp
Q26	BUFFER AMP	B band IF AGC amp (57.6MHz)
Q27	local AMP	B band 2nd local (crystal oscillator) buffer amp

Ref. No.	DESCRIPTION NAME	Use/function
Q28	MIXER	B band
Q29	AF SW	B band AF output SW
Q30	SW	B band FM / W-FM power supply SW
Q31	RIPPLE FILTER	A band VCO power supply
Q32	ANT SW	Bar antenna switch
Q34	OSCILLATOR	A band VCO oscillator
Q35	VCO power supply SW	A band RX VCO power supply switching
Q37	BUFFER AMP	A band RX VCO output amp
Q40	RF AMP	A band local amp
Q41	RF AMP	A band mixer input amp
Q43	IF AMP	A band 1st IF amp
Q44	RF AMP	A band 2nd local multiplyng
Q45	MIXER	A band
Q46	RF AMP	B band 1.2GHz band 1st amp
Q47	APC SW	APC control
Q48	ANT SW	Bar antenna switch
Q49	APC controller	APC control
Q50	AMP	APC control
Q51	APC SW	APC control
Q52	ANT SW	Bar antenna switch
Q53	DC SW	Bias control
Q54	RF AMP	Pre-drive
Q55	RF AMP	VHF/UHF final-amp
Q56	RF AMP	Drive amp
Q57	RF AMP	220MHz band final-amp (K-type only)
Q58	Power supply switch	B band 2nd amp power supply control
Q59	RF AMP	Bar antenna 1st amp
Q62	RF AMP	UHF 1st amp (A/B band)
Q63	RF AMP	A band VHF 1st amp
Q64	RF AMP	B band VHF 1st amp
Q65	DC IN DETECT SW	DC-IN / battery
Q66	APC SW	APC control
Q68	SW	BPF SW
Q69	VCO switching	VCO oscillator frequency shift SW
Q70	VCO switching	VCO oscillator frequency shift SW
Q71	RF AMP	Drive amp
Q72	RF AMP	Pre-amp
Q73	BAND SW	B band 50 to 108MHz On when RX
Q74	BAND SW	B band 50 or less On when RX
Q76	RF AMP	B band 50 to 108MHz On when RX
Q92	Power supply switch	B band 1.2GHz band 1st amp power supply SW
Q93	RF AMP	B band local amp
Q94	RF SW	PLL Fin filter SW
Q95,96	SW	Final SW
Q97	RF AMP	B band local amp
Q98	GAIN SW	Bar antenna RF amp gain SW
Q99	DC SW	Bias control
Q100	IF SW	when bar antenna use : ON

TH-F6A/F7E

DESCRIPTION OF COMPONENTS / SEMICONDUCTOR DATA

Ref. No.	DESCRIPTION NAME	Use/function
Q701	VOX AMP	
Q702	impedance	9600bps transmitter
Q703	BEAT SHIFT	
Q704	AF SP MUTE SW	
Q705	RAMP SW	
Q706	AF SP MUTE SW	Ext speaker
Q707	MIC MUTE SW	
Q708	AF SP MUTE SW	
Q709	AUDIO AVR SW	
Q710	AVR	
Q712	VTx SW	
Q713	VSSB&VRB SW	
Q714	M4S SW	
Q715	VRA&VCV SW	
Q716	VVOX SW	when VOX mode ON
Q719	Rx AF filter	
Q720	RX packet AMP	
Q721,722	impedance conversion	9600bps receiving
Q723	TNC cotrol SW	
Q725	Audio AVR	
Q726	Voltage cotro SW	
Q727	LCD DRIVE SW	
Q728	AVR SW	
Q729	NOISE SHIFT SW	

● Microcomputer pin functions

μPD784216(IC705)

Pin No.	I/O	Pin name	Active level	Function
1	I	LDB	L	B band PLL lock detect H:Lock
2	I	LDA	L	A band PLL lock detect H:Lock
3	O	PLF1	H	PLL filter switch
4	I	CHGI	L	charging detection L:Charging
5	O	VRBS	L	B band receiver power supply when receiving:L
6	O	BRXSW1	H	Prescaler
7	O	BRXSW2	H	Prescaler
8	O	BVCOSW	H	B band VCO double switch H:Upper
9	-	---	---	Positive power supply
10	O	---	---	System clock
11	I	---	---	System clock
12	-	---	---	Ground
13	-	---	---	Open
14	-	---	---	Connect to VSS
15	I	RESET	H	System reset L:Reset[3.0V]
16	I	INT		Power supply voltage drop detection interrupt 3.5[V]
17	O	LEA		A band PLL enable H:Enable
18	O	LEB	---	B band PLL enable H:Enable
19	I	EN2		Encoder data input
20	I	EN1		Encoder interrupt
21	I	PWR	L	[PWR] Switch interrupt L:pressed
22	I	DCDET	L	DC-IN detection L:DC-IN connect
23,24	-	---	---	Connect to VDD
25	I	BATT	---	Battery voltage level A/D input
26	I	SQB	---	B band noise level A/D input
27	I	SMA	---	A band S meter level A/D input
28	I	SMB	---	B band S meter level A/D input
29	I	REM	---	Remote control microphone key A/D input
30	I	VOXIn	---	VOX sensitivity A/D input
31	I	TOIn	---	TONE detection input pin
32	I	SQA&THM	---	A band noise level & temperature- compensated thermistor voltage A/D input
33	-	---	---	Connect to VSS
34	O	1750/DTMF		DTMF tone,1750Hz tone D/A output
35	O	TONE		Subtone D/A output
36	-	---	---	Connect to VDD
37	O	SAVE	L	Save L:ON

SEMICONDUCTOR DATA

Pin No.	I/O	Pin name	Active level	Function
38	O	LAPS	H	Key, LCD illumination power supply H:ON
39	O	AFC	H	Audio amp power supply SW, key,LCD illumination, power supply SW H:ON
40	I	RxD1	L	UART data input from PC pin
41	O	TxD1	L	UART data output to PC pin
42	O	AFV	L	AF mute switch L:DCS,CTCSS ON
43	O	RESLCD	H	LCD driver reset L:Reset
44	O	R0LCD	---	LCD driver data type bit L:Control H:Display
45	O	ELCD		LCD driver enable H:Enable
46	O	RWLCD	---	LCD driver read/write L:write
47	O	MIC MUTE	H	Micmute switch H:MUTE
48-55	I/O	D0-7	---	LCD driver data line
56-60	I	KEY11-5	L	Key matrix input 1-5
61	I	TYPE	L	Destination, channel display mode diode input
62	O	96H	H	9600BPSH:ON
63	O	ABS		TONE band switch H:B band L:A band
64-68	O	KEYO1-5	L	Key matrix output 1-5
69	O	LCK		Shift register enable H:ON
70	I	PTT2	L	External [PTT] key input L:pressed
71	O	M4SS	H	M4SSW H:ON
72	-	---	---	Ground
73	O	BVCOS	H	B Band VCO select switch H:VCO2
74	O	WFMS	L	W-FM switch L:WFM
75	O	BAMS	L	B Band FM detector switch L:FM,WFM mode
76	O	DACEN	---	D/A enable
77	O	SPM	H	Receiving on mute SW L:MUTE
78	O	BMS	H	Band matching SW
79	O	BUSY	L	9600bps BUSY output H:BUSY
80	O	BSHIFT	L	Beet shift SW H:ON
81	-	---	---	Positive power supply
82	O	VVOXS	L	VOX power supply VOX ON, at TX:L
83	O	VSSBS	L	SSB power supply L:SSB,CW
84	O	APC/BPFA	---	APC & A BPF tuning PWM output 144,220MHz band receive

Pin No.	I/O	Pin name	Active level	Function
85	O	BPFB	---	B band BPF PWM output input with the bar antenna
86	O	VRAS	L	A Band receiver power supply Receiving:L
87	O	BEEP		Beep output
88	I	SI		EEPROM data input line (EEPROM SO pin)
89	O	CLK		Common clock line
90	O	DATA		Common data line
91	O	CS		EEPROM chip select L:Enable
92	O	VTXS	L	Transmission power supply L:Transmission
93	O	VCVS	L	B band VCO, PLL power supply switch L:B band ON
94	I	VPP/TEST		Flash write 10V application pin Normally:L
95	O	RLEDA	L	A band busy LED L:ON
96	O	TLEDA	L	A band transmission LED L:ON
97	O	RLEDB	L	B band busy LED L:ON
98	O	TLEDB	L	B band transmission LED L:ON
99	I	PTT1	L	PTT SW(main) L:Transmisson
100	O	TXL	H	Transmission VCO1 shift H:Shift ON

SEMICONDUCTOR DATA

● Terminal Functions

Connector No.	NO	Name	Terminal function
CN7 ↑ CN716 ↓	1	APC & TUNEA	APC&A band BPF tuning voltage
	2	BMS	Band matching switch
	3	PLF1	PLL filter switch
	4	CHGI	Charge detect interrupt
	5	LDB	B band PLL lock detection
	6	BVCOSW	B band VCO doubler SW
	7	DCDET	DC-IN detection
	8	LDA	A band PLL lock detection
	9	SW1	Prescaler divide
	10	SW2	Prescaler divide
	11	LEB	B band PLL enable
	12	AFB	B band audio output
	13	LEA	A band PLL enable
	14	AFA	A band audio output
	15	FINE2	3rd local control voltage
	16	B	Battery power
	17	FINE1	2nd local control voltage
	18	MOD	Modulation signal input
	19	LCK	Shift register enable
	20	CLK	Common clock
	21	TXL	VCO shift
	22	DATA	Common data
	23	THM&SQA	Thermal detection & A band squelch voltage
	24	C8	Charge pump power supply
	25	SMB	B band S-meter voltage
	26	VTX	Transmission power supply
	27	SQB	B band squelch voltage
	28	VRB	B band RX voltage
	29	SMA	A band s meter voltage
	30	VRA	A band RX power supply
	31	M4S	AVR power supply
	32	VCV	B band VCO, PLL power supply
	33	VTUNEB	B band BPF tuning voltage
	34	VC	Power supply
	35	BAMS	B band AM power supply
	36	BSS	B band PLL fin filter switch
	37	VXTAL	TCXO modulation signal
	38	WFMS	W-FM power supply
	39	GND	GND
	40	VSSB	SSB,CW power supply
CN8	1	GND	GND
	2	MBCV	B band VCO control voltage
	3	MACV	A band VCO control voltage
	4	MOD	Modulation signal
	5	MAVCOS	A band VCO SW
	6	BSS	B band PLL fin filter SW
	7	A220S	A band PLL fin filter SW
	8	TXL	B band VCO shift
	9	VRA	A band RX power supply
	10	VCV	B band VCO, PLL power supply
	11	MAOUT	A band VCO output signal

Connector No.	NO	Name	Terminal function
CN8	12	MBOUT	B band VCO output signal
CN9	1	GND	GND
	2	DBCX	B band VCO control voltage
	3	DACV	A band VCO control voltage
	4	DMOD	Modulation signal
	5	DAVCOS	A band VCO SW
	6	DBSS	B band VCO SW
	7	DA220S	A band VCO shift
	8	DTXL	B band VCO shift
	9	DVRA	A band RX power supply
	10	DVCV	B band VCO, PLL power supply
	11	DAOUT	A band VCO output signal
	12	DBOUT	B band VCO, output signal
CN713	1	NC	NC
	2	IM1	Interface mode specify
	3	OPDFF/TEST/IMO/ID	Parallel bus specify
	4-11	DB7-0	LCD driver data bus
	12	RESET	LCD driver data reset
	13	CS	Chip select signal (L)
	14	RS	LCD driver register select signal
	15	E	LCD driver enable
	16	RW/RD	LCD driver read /write
	17	GND	GND
	18	OSC2	CR oscillator
	19	OSC1	CR oscillator
	20	Vcc	Power supply
	21	Vci	Reference voltage output, boost circuit power supply
	22	C1+	Boost voltage circuit
	23	C1-	Boost voltage circuit
	24	VLOUT	Boost voltage output
25	VLCD	LCD power supply	
26	V1OUT	output voltage V1	
27	V2OUT	output voltage V2	
28	V3OUT	output voltage V3	
29	V4OUT	output voltage V4	
30	V5OUT	output voltage V5	
CN714	1	GND	GND
	2	AFVO	AF output
	3	AFVI	AF input
	4	EN2	Encoder pulse 2
	5	GND	GND
	6	EN1	Encoder pulse 1
CN715	1	SP+	SP
	2	SP-	GND

PARTS LIST

* New Parts. Δ indicates safety critical components.
 Parts without **Parts No.** are not supplied.
 Les articles non mentionnés dans le **Parts No.** ne sont pas fournis.
 Teile ohne **Parts No.** werden nicht geliefert.

L: Scandinavia K: USA P: Canada
 Y: PX (Far East, Hawaii) T: England E: Europe
 Y: AAFES (Europe) X: Australia M: Other Areas

TH-F6A/F7E

TX-RX UNIT (X57-6360-00)

Ref. No.	Address	New parts	Parts No.	Description	Destination	Ref. No.	Address	New parts	Parts No.	Description	Destination
TH-F6A/F7E											
1	1A	*	A02-3727-03	CABINET ASSY		45	2B	*	K29-9109-03	LEVER KNOB (RELEASE)	
2	3A	*	A10-4050-01	CHASSIS		46	1A	*	K29-9110-03	KNOB (PTT)	
3	3B	*	A82-0046-02	REAR PANEL		47	1A	*	K29-9111-03	KNOB (MULTI-F)	
4	1B	*	B09-0615-23	CAP (MIC/SP/DC)		48	-		L79-1417-05	LINE FILTER	T,E
5	1A	*	B10-2685-13	FRONT GLASS	T,E	A	3B		N09-1492-05	PAN HEAD SCREW (SMA)	
5	1A	*	B10-2723-13	FRONT GLASS	K	B	-	*	N09-2385-05	BINDING HEAD SCREW (HOOK)	
6	2B	*	B11-1280-04	ILLUMINATION GUIDE (LCD)		C	1B		N14-0573-04	CIRCULAR NUT (SMA)	
7	2B	*	B11-1281-04	FILTER (LCD)		D	1B	*	N14-0593-04	CIRCULAR NUT (VOL/ENC)	
8	2B	*	B38-0852-15	LCD ASSY		E	2A		N79-2035-45	PAN HEAD TAPTITE SCREW	
9	-	*	B62-1441-00	INSTRUCTION MANUAL(ENG/SPA)		F	2A,2B	*	N79-2040-46	PAN HEAD TAPTITE SCREW	
9	-	*	B62-1442-00	INSTRUCTION MANUAL(FRE/ITA)	E	G	3A		N80-2008-45	PAN HEAD TAPTITE SCREW	
9	-	*	B62-1443-00	INSTRUCTION MANUAL(NET/GER)	E	H	2A		N83-2006-45	PAN HEAD TAPTITE SCREW	
10	-	*	B72-2054-14	MODEL NAME PLATE	K	49	2B		R39-0602-05	VARIABLE RESISTOR	
10	-	*	B72-2055-04	MODEL NAME PLATE	T,E	SP	1B		T07-0266-05	SPEAKER	
11	2B	*	D21-0856-04	SHAFT (RELEASE)		50	-	*	T90-0781-05	WHIP ANTENNA	K
12	3B		E04-0407-15	RF COAXIAL RECEPTACLE(SMA)		50	-	*	T90-0789-05	WHIP ANTENNA	T,E
13	2B	*	E23-1177-04	RELAY TERMINAL (BATTERY)		ANT	2A	*	T90-0787-05	ANTENNA (Bar antenna)	
14	2B	*	E23-1180-04	GROUND TERMINAL(SMA)		51	-	*	W08-0927-05	AC ADAPTER	K
15	1B		E37-0695-05	LEAD WIRE WITH CONNECTOR(SP)		51	-	*	W08-0928-05	AC ADAPTER	E
16	-	*	F07-1859-03	COVER (HOOK)		51	-	*	W08-0929-05	AC ADAPTER	T
17	2B	*	F10-2411-04	SHIELDING COVER(ANTENNA)		53	3A		X57-6362-01	VCO UNIT	
18	2A	*	F10-2437-04	SHIELDING PLATE(BAR-ANTENNA)		TX-RX UNIT (X57-6360-00) 0-11:K, 2-71:T,E					
19	1B	*	F12-0464-14	SHIELDING SHEET(LCD)		D712,713			B30-2131-05	LED	
20	1B	*	F15-1002-04	SHADOW PLATE (LCD)		D714-717			B30-2210-05	LED(TLY)	
21	1B	*	F15-1004-04	SHADOW PLATE (TX-RX)		D720-725			B30-2157-05	LED(YELLOW)	
23	2A	*	F20-3325-04	INSULATING SHEET		C1			CK73HB1H471K	CHIP C 470PF	K
24	1B,2B	*	F20-3336-04	INSULATING SHEET		C2			CK73HB1H102K	CHIP C 1000PF	K
25	2B	*	G01-4532-04	COIL SPRING (RELEASE)		C3,4			CC73HCH1H101J	CHIP C 100PF	J
26	3A	*	G11-4060-04	RUBBER SHEET		C5			CK73HB1H102K	CHIP C 1000PF	K
27	3A	*	G13-1858-14	CUSHION (CHASSIS)		C6			CK73HB1C103K	CHIP C 0.010UF	K
28	2A	*	G13-1860-04	CUSHION (BAR-ANTENNA)		C7			CK73HB1A104K	CHIP C 0.10UF	K
29	3B	*	G53-1529-04	PACKING (VOL/ENC)		C8			CK73HB1H471K	CHIP C 470PF	K
30	3A	*	G53-1532-02	PACKING (CASE)		C9,10			CK73HB1C103K	CHIP C 0.010UF	K
31	2A	*	G53-1533-03	PACKING (MULTI-F)		C11			CK73HB1H471K	CHIP C 470PF	K
32	2B	*	G53-1534-13	PACKING (SP/MIC)		C12			CC73HCH1H680J	CHIP C 68PF	J
33	-	*	H52-1857-02	ITEM CARTON CASE	K	C13			CK73HB1A104K	CHIP C 0.10UF	K
33	-	*	H52-1858-02	ITEM CARTON CASE	T,E	C14			CC73HCH1H120J	CHIP C 12PF	J
34	3A	*	J19-5428-03	HOLDER (TERMINAL)		C15,16			CK73HB1A104K	CHIP C 0.10UF	K
35	2A	*	J19-5429-13	HOLDER (BER-ANTENNA)		C17,18			CK73HB1H471K	CHIP C 470PF	K
36	2B	*	J21-8419-03	HARDWARE FIXTURE(LCD)		C19			CK73GB0J105K	CHIP C 1.0UF	K
37	-		J29-0623-04	BELT HOOK		C20			CK73HB1C103K	CHIP C 0.010UF	K
38	2A	*	J32-0927-04	CYLINDRICAL BOSS		C21			CC73HCH1H102J	CHIP C 1000PF	J
39	-		J69-0342-05	HANDSTRAP		C22			CK73HB1H471K	CHIP C 470PF	K
40	2B	*	J82-0076-05	FPC (VOL/ENC)		C23			CK73HB1H102K	CHIP C 1000PF	K
41	1B	*	K29-5150-03	KNOB (VOL)		C24			CC73HCH1H101J	CHIP C 100PF	J
42	1B	*	K29-5159-03	KNOB (ENC)		C25			CC73HCH1H680J	CHIP C 68PF	J
43	2A	*	K29-9107-12	KEY TOP		C26-28			CC73HCH1H220J	CHIP C 22PF	J
44	1A	*	K29-9108-13	KNOB (PTT/MONI)		C29,30			CK73HB1A104K	CHIP C 0.10UF	K
						C31,32			CK73HB1H471K	CHIP C 470PF	K
						C33			CK73HB1H102K	CHIP C 1000PF	K

TH-F6A/F7E

PARTS LIST

TX-RX UNIT (X57-6360-00)

Ref. No.	Address	New parts	Parts No.	Description	Destination	Ref. No.	Address	New parts	Parts No.	Description	Destination
C34			CC73HCH1H101J	CHIP C 100PF J		C123			CC73HCH1H101J	CHIP C 100PF J	
C36			C92-0518-05	CHIP-TAN 0.22UF 20WV		C126			CK73FB1C105K	CHIP C 1.0UF K	
C37			CK73HB1H471K	CHIP C 470PF K		C127			CK73HB1C103K	CHIP C 0.010UF K	
C40			CK73HB1C103K	CHIP C 0.010UF K		C129			CK73HB1C103K	CHIP C 0.010UF K	
C41			C92-0766-05	CHIP-TAN 4.7UF 6.3WV		C130			CK73HB1H332K	CHIP C 3300PF K	
C42			CK73HB1C103K	CHIP C 0.010UF K		C133,134			CK73HB1C103K	CHIP C 0.010UF K	
C43			C92-0555-05	CHIP-TAN 0.047UF 35WV		C135			CK73HB1A104K	CHIP C 0.10UF K	
C44			CK73HB1H471K	CHIP C 470PF K		C137			CK73HB1H152K	CHIP C 1500PF K	
C45			C92-0542-05	CHIP-TAN 0.10UF 20WV		C138			CK73HB1A104K	CHIP C 0.10UF K	
C46			CK73HB1C103K	CHIP C 0.010UF K		C139			CC73HCH1H101J	CHIP C 100PF J	
C47,48			CK73HB1H471K	CHIP C 470PF K		C140			CK73HB1H821K	CHIP C 820PF K	
C49			CC73HCH1H0R5B	CHIP C 0.5PF B		C141			CK73HB1C103K	CHIP C 0.010UF K	
C50			CC73HCH1H010B	CHIP C 1.0PF B		C143			CK73HB1C103K	CHIP C 0.010UF K	
C51			CK73HB1H471K	CHIP C 470PF K		C145			CK73HB1H102K	CHIP C 1000PF K	
C52			C92-0772-05	CHIP-TAN 10UF 6.3WV		C147			C92-0772-05	CHIP-TAN 10UF 6.3WV	
C53			CK73HB1H471K	CHIP C 470PF K		C149			CK73GB1A474K	CHIP C 0.47UF K	
C54			CK73HB1A104K	CHIP C 0.10UF K		C150			CK73HB1A104K	CHIP C 0.10UF K	
C55-57			CK73HB1H471K	CHIP C 470PF K		C151			CK73HB1H102K	CHIP C 1000PF K	
C58,59			CK73HB1A104K	CHIP C 0.10UF K		C152			CK73HB1A104K	CHIP C 0.10UF K	
C60-62			CK73HB1H471K	CHIP C 470PF K		C154			CK73HB1H102K	CHIP C 1000PF K	
C64			CK73HB1C103K	CHIP C 0.010UF K		C155			C92-0772-05	CHIP-TAN 10UF 6.3WV	
C65			CC73HCH1H060B	CHIP C 6.0PF B		C156,157			CK73HB1H102K	CHIP C 1000PF K	
C66			CC73HCH1H150J	CHIP C 15PF J		C158-160			CK73HB1A104K	CHIP C 0.10UF K	
C67			CC73HCH1H060B	CHIP C 6.0PF B		C161			CK73HB1H102K	CHIP C 1000PF K	
C68,69			CK73HB1H471K	CHIP C 470PF K		C162			CK73HB1A104K	CHIP C 0.10UF K	
C70			CK73HB1C103K	CHIP C 0.010UF K		C163,164			CC73HCH1H101J	CHIP C 100PF J	
C71			CC73HCH1H070B	CHIP C 7.0PF B		C165			CK73HB1A104K	CHIP C 0.10UF K	
C72			CK73HB1H471K	CHIP C 470PF K		C166			CC73HCH1H330J	CHIP C 33PF J	
C75		*	CC73HCH1H100C	CHIP C 10PF C		C167			CC73HCH1H070B	CHIP C 7.0PF B	
C76,77			CK73HB1H471K	CHIP C 470PF K		C168			CK73HB1A104K	CHIP C 0.10UF K	
C78			CC73HCH1H0R5B	CHIP C 0.5PF B		C169			C92-0772-05	CHIP-TAN 10UF 6.3WV	
C79,80			CK73HB1H471K	CHIP C 470PF K		C170-173			CK73HB1A104K	CHIP C 0.10UF K	
C82			CC73HCH1H0R5B	CHIP C 0.5PF B		C174			CK73HB1H102K	CHIP C 1000PF K	
C83			CC73HCH1H220J	CHIP C 22PF J		C175			CK73HB1A104K	CHIP C 0.10UF K	
C84,85			CK73HB1C103K	CHIP C 0.010UF K		C177			C92-0772-05	CHIP ELECTR 470UF 10WV	
C86,87			CK73HB1H471K	CHIP C 470PF K		C178			CK73HB1H102K	CHIP C 1000PF K	
C88			CK73HB1A104K	CHIP C 0.10UF K		C179			CK73HB1A104K	CHIP C 0.10UF K	
C89			CK73HB1H471K	CHIP C 470PF K		C180			CC73HCH1H030C	CHIP C 3.0PF C	
C90,91		*	CC73HCH1H100C	CHIP C 10PF C		C181			CK73HB1C103K	CHIP C 0.010UF K	
C94			CC73HCH1H080B	CHIP C 8.0PF B		C182			CC73HCH1H120J	CHIP C 12PF J	
C95			CC73HCH1H030C	CHIP C 3.0PF C		C183,184			CK73HB1C103K	CHIP C 0.010UF K	
C97			CC73HCH1H080B	CHIP C 8.0PF B		C186			CC73HCH1H270J	CHIP C 27PF J	
C102,103			CK73HB1C103K	CHIP C 0.010UF K		C188			CC73HCH1H050C	CHIP C 5.0PF C	
C104			CK73HB1H471K	CHIP C 470PF K		C189		*	CC73HCH1H100C	CHIP C 10PF C	
C105			CK73HB1H102K	CHIP C 1000PF K		C190			CC73HCH1H120J	CHIP C 12PF C	
C106			CK73HB1H471K	CHIP C 470PF K		C191			CK73HB1A104K	CHIP C 0.10UF K	
C107			CC73HCH1H050C	CHIP C 5.0PF C		C192			CK73HB1C103K	CHIP C 0.010UF K	
C108		*	CC73HCH1H100C	CHIP C 10PF C		C193			CC73HCH1H060B	CHIP C 6.0PF B	
C109,110			CK73HB1H471K	CHIP C 470PF K		C195			CK73HB1H471K	CHIP C 470PF K	
C112			CK73HB1H102K	CHIP C 1000PF K		C196			CC73HCH1H220J	CHIP C 22PF J	
C113			CK73HB1H471K	CHIP C 470PF K		C199			CC73HCH1H121J	CHIP C 120PF J	
C114,115			CC73HCH1H101J	CHIP C 100PF J		C200			CK73HB1H102K	CHIP C 1000PF K	
C116			CC73HCH1H050C	CHIP C 5.0PF C		C202			CK73HB1C103K	CHIP C 0.010UF K	
C117			CC73HCH1H101J	CHIP C 100PF J		C203			CC73HCH1H330J	CHIP C 33PF J	
C119			CK73HB1C103K	CHIP C 0.010UF K		C205,206			CK73HB1C103K	CHIP C 0.010UF K	
C121			CC73HCH1H060B	CHIP C 6.0PF B		C208			CK73HB1C103K	CHIP C 0.010UF K	

PARTS LIST

TX-RX UNIT (X57-6360-00)

Ref. No.	Address	New parts	Parts No.	Description	Destination	Ref. No.	Address	New parts	Parts No.	Description	Destination
C209			CC73HCH1H101J	CHIP C 100PF J		C283			CK73HB1H471K	CHIP C 470PF K	
C210			CC73HCH1H330J	CHIP C 33PF J		C284			CC73HCH1H090D	CHIP C 9.0PF D	
C211			CK73HB1C103K	CHIP C 0.010UF K		C285			CC73HCH1H820J	CHIP C 82PF J	
C212,213			CC73HCH1H101J	CHIP C 100PF J		C286			CK73HB1A104K	CHIP C 0.10UF K	
C214			CK73HB1H102K	CHIP C 1000PF K		C287			CK73HB1A104K	CHIP C 0.10UF K	
C215			CK73HB1C103K	CHIP C 0.010UF K		C288			CK73HB1A104K	CHIP C 0.10UF K	
C217		*	CC73HCH1H100C	CHIP C 10PF C		C289			CC73HCH1H330J	CHIP C 33PF J	
C218			CC73HCH1H470J	CHIP C 47PF J		C290,291			CC73HCH1E181J	CHIP C 180PF J	
C219			CK73HB1H471K	CHIP C 470PF K		C292			CK73HB1A104K	CHIP C 0.10UF K	
C220,221			CK73HB1A104K	CHIP C 0.10UF K		C293			CK73HB1H102K	CHIP C 1000PF K	
C222			CK73HB1H471K	CHIP C 470PF K		C295			CK73HB1C103K	CHIP C 0.010UF K	
C223			CK73HB1H102K	CHIP C 1000PF K		C296			CC73HCH1H150J	CHIP C 15PF J	
C224			CC73HCH1H470J	CHIP C 47PF J		C297			CC73HCH1H560J	CHIP C 56PF J	
C225,226			CK73HB1H471K	CHIP C 470PF K		C298,299			CK73HB1H102K	CHIP C 1000PF K	
C227			CK73HB1H561K	CHIP C 560PF K		C301			C92-0772-05	CHIP-TAN 10UF 6.3WV	
C228			C92-0003-05	CHIP-TAN 0.47UF 25WV		C302			CK73HB1H471K	CHIP C 470PF K	
C229			C92-0766-05	CHIP-TAN 4.7UF 6.3WV		C303			CC73HCH1H080B	CHIP C 8.0PF B	
C230			C92-0555-05	CHIP-TAN 0.047UF 35WV		C305			CK73HB1H102K	CHIP C 1000PF K	
C231,232			CK73HB1H471K	CHIP C 470PF K		C306			CC73HCH1H150J	CHIP C 15PF J	
C233			CK73HB1A104K	CHIP C 0.10UF K		C307			CK73HB1C103K	CHIP C 0.010UF K	
C234			CK73HB1H561K	CHIP C 560PF K		C308			CK73HB1H471K	CHIP C 470PF K	
C235			C92-0772-05	CHIP-TAN 10UF 6.3WV		C309			CK73HB1C103K	CHIP C 0.010UF K	
C236			CK73HB1H471K	CHIP C 470PF K		C310-314			CK73HB1H471K	CHIP C 470PF K	
C237			CK73HB1A104K	CHIP C 0.10UF K		C315			CC73HCH1H220J	CHIP C 22PF J	
C238			CK73HB1C103K	CHIP C 0.010UF K		C317-322			CK73HB1H471K	CHIP C 470PF K	
C239			CK73HB1H561K	CHIP C 560PF K		C323			C92-0772-05	CHIP-TAN 10UF 6.3WV	
C240,241			CC73HCH1H010B	CHIP C 1.0PF B		C324-328			CK73HB1H471K	CHIP C 470PF K	
C242			CC73HCH1E181J	CHIP C 180PF J		C331,332			CK73HB1H471K	CHIP C 470PF K	
C245			CK73HB1H102K	CHIP C 1000PF K		C333			CC73HCH1H330J	CHIP C 33PF J	
C246			CC73HCH1H070B	CHIP C 7.0PF B		C334,335			CK73HB1H471K	CHIP C 470PF K	
C247		*	CC73HCH1H100C	CHIP C 10PF C		C336			CK73HB1H102K	CHIP C 1000PF K	
C248			CC73HCH1H120J	CHIP C 12PF J		C337			CC73HCH1H470J	CHIP C 47PF J	
C249			CK73HB1H471K	CHIP C 470PF K		C338			CC73HCH1H270J	CHIP C 27PF J	
C251			CK73HB1H471K	CHIP C 470PF K		C339			CK73GB1H471K	CHIP C 470PF K	
C252			CC73HCH1H070B	CHIP C 7.0PF B		C340			CK73HB1A104K	CHIP C 0.10UF K	
C253			CK73HB1H561K	CHIP C 560PF K		C341			CC73HCH1H070B	CHIP C 7.0PF B	
C254			CC73HCH1H0R5B	CHIP C 0.5PF B		C343			CC73HCH1H120J	CHIP C 12PF J	
C255			CK73HB1H471K	CHIP C 470PF K		C344			CC73HCH1H150J	CHIP C 15PF J	
C256			CK73HB1C103K	CHIP C 0.010UF K		C345-347			CK73HB1H471K	CHIP C 470PF K	
C259			CC73HCH1H0R5B	CHIP C 0.5PF B		C348,349			CC73GCH1H680J	CHIP C 68PF J	
C260		*	CC73HCH1H100C	CHIP C 10PF C		C350			CC73GCH1H270J	CHIP C 27PF J	
C261			CK73HB1H471K	CHIP C 470PF K		C351			CC73GCH1H220J	CHIP C 22PF J	K
C263		*	CC73HCH1H100C	CHIP C 10PF C		C351			CC73GCH1H270J	CHIP C 27PF J	T,E
C264			CC73HCH1H220J	CHIP C 22PF J		C352			CK73HB1H471K	CHIP C 470PF K	
C265			CK73HB1H471K	CHIP C 470PF K		C353			CK73FB1C105K	CHIP C 1.0UF K	
C266			CK73HB1A104K	CHIP C 0.10UF K		C354			CC73GCH1H330J	CHIP C 33PF J	K
C269			CC73HCH1H120J	CHIP C 12PF J		C354			CC73GCH1H360J	CHIP C 36PF J	T,E
C270			CC73HCH1H020B	CHIP C 2.0PF B		C356			CC73GCH1H270J	CHIP C 27PF J	K
C271			CC73HCH1H120J	CHIP C 12PF J		C356			CC73GCH1H330J	CHIP C 33PF J	T,E
C272		*	CC73HCH1H100C	CHIP C 10PF C		C357			CC73GCH1H120J	CHIP C 12PF J	
C274			CC73HCH1H101J	CHIP C 100PF J		C358			CC73HCH1H101J	CHIP C 100PF J	
C277			CK73HB1H561K	CHIP C 560PF K		C360,361			CK73HB1H471K	CHIP C 470PF K	
C278			CC73HCH1H0R5B	CHIP C 0.5PF B		C362			CK73HB1C103K	CHIP C 0.010UF K	
C280			CK73FB1C105K	CHIP C 1.0UF K		C363			CC73GCH1H130J	CHIP C 13PF J	
C281			CK73HB1C103K	CHIP C 0.010UF K		C368			CK73HB1H471K	CHIP C 470PF K	
C282			CC73HCH1H150J	CHIP C 15PF J		C373			CC73GCH1H220J	CHIP C 22PF J	

TH-F6A/F7E

PARTS LIST

TX-RX UNIT (X57-6360-00)

Ref. No.	Address	New parts	Parts No.	Description	Destination	Ref. No.	Address	New parts	Parts No.	Description	Destination
C376			CC73HCH1H050C	CHIP C 5.0PF C	K	C463-474			CK73HB1C103K	CHIP C 0.010UF K	
C377			CK73HB1A104K	CHIP C 0.10UF K		C475			CK73HB1H471K	CHIP C 470PF K	
C378			CK73HB1H471K	CHIP C 470PF K		C476,477			CK73HB1C103K	CHIP C 0.010UF K	
C381			CC73HCH1H101J	CHIP C 100PF J		C484			CC73GCH1H020B	CHIP C 2.0PF B	K
C382			CC73GCH1H200J	CHIP C 20PF J	K	C484			CC73GCH1H030C	CHIP C 3.0PF C	T,E
C387,388			CK73HB1H102K	CHIP C 1000PF K		C485			CC73HCH1H470J	CHIP C 47PF J	
C389			CC73HCH1H080B	CHIP C 8.0PF B		C488			CC73HCH1H030C	CHIP C 3.0PF C	
C390			CK73HB1A104K	CHIP C 0.10UF K		C489			CC73HCH1H101J	CHIP C 100PF J	
C392			CC73HCH1H150J	CHIP C 15PF B	K	C490			CC73HCH1H470J	CHIP C 47PF J	
C395			CK73HB1H102K	CHIP C 1000PF K		C491			CC73HCH1H101J	CHIP C 100PF J	
C396			CK73HB1H471K	CHIP C 470PF K		C492			CC73HCH1H101J	CHIP C 100PF J	
C407			CC73GCH1H100C	CHIP C 10PF C		C494			CK73HB1H471K	CHIP C 470PF K	
C408			CC73HCH1H050C	CHIP C 5.0PF C	K	C495			CC73HCH1H150J	CHIP C 15PF J	T,E
C408			CC73HCH1H070B	CHIP C 7.0PF B	T,E	C497			CC73HCH1H040C	CHIP C 4.0PF C	
C409			CC73GCH1H150J	CHIP C 15PF J	K	C498			CC73HCH1H030C	CHIP C 3.0PF C	T,E
C409			CC73GCH1H220J	CHIP C 22PF J	T,E	C498			CC73HCH1H150J	CHIP C 15PF J	K
C410			CC73GCH1H010B	CHIP C 1.0PF B	K	C499			CC73HCH1H050B	CHIP C 5.0PF C	K
C410			CC73GCH1H020B	CHIP C 2.0PF B	T,E	C499	*		CC73HCH1H130J	CHIP C 13PF J	T,E
C411			CK73HB1H471K	CHIP C 470PF K		C500			CC73HCH1H080B	CHIP C 8.0PF B	K
C412			CC73HCH1H020B	CHIP C 2.0PF B		C500			CC73HCH1H040C	CHIP C 4.0PF C	T,E
C413			CC73HCH1H050C	CHIP C 5.0PF C		C501			CC73HCH1H040C	CHIP C 4.0PF C	
C414			CC73GCH1H080D	CHIP C 8.0PF D		C502			CC73HCH1H050C	CHIP C 5.0PF C	K
C415			CC73HCH1H010B	CHIP C 1.0PF B		C502			CC73HCH1H150J	CHIP C 15PF J	T,E
C416			CC73GCH1H110J	CHIP C 11PF J		C503			CC73HCH1H101J	CHIP C 100PF J	
C417			CC73HCH1H0R5B	CHIP C 0.5PF B		C504			CC73HCH1H070B	CHIP C 7.0PF B	T,E
C418			CC73GCH1H040B	CHIP C 4.0PF B		C504			CC73HCH1H120J	CHIP C 12PF J	K
C419			CC73GCH1H220J	CHIP C 22PF J		C505			CK73HB1H471K	CHIP C 470PF K	
C420			CC73HCH1H101J	CHIP C 100PF J		C506			CC73HCH1H060B	CHIP C 6.0PF B	K
C421	*		CC73HCH1H100C	CHIP C 10PF C		C506			CC73HCH1H180J	CHIP C 18PF J	T,E
C428			CC73HCH1H050C	CHIP C 5.0PF C	K	C507			CC73HCH1H080B	CHIP C 8.0PF B	K
C428			CC73HCH1H070B	CHIP C 7.0PF B	T,E	C507			CC73HCH1H220J	CHIP C 22PF J	T,E
C429			CC73GCH1H180J	CHIP C 18PF J		C508-510			CK73HB1H471K	CHIP C 470PF K	
C430			CC73GCH1H070B	CHIP C 7.0PF B		C511			CC73HCH1H050C	CHIP C 5.0PF C	K
C436			CC73HCH1H090D	CHIP C 9.0PF D		C511	*		CC73HCH1H100C	CHIP C 10PF C	T,E
C437			CC73HCH1H220J	CHIP C 22PF J		C512,513			CK73HB1H102K	CHIP C 1000PF K	
C438			CC73HCH1H050C	CHIP C 5.0PF C		C515,516			CK73HB1H102K	CHIP C 1000PF K	
C439			CC73HCH1H040C	CHIP C 4.0PF C		C517			CC73HCH1H0R5B	CHIP C 0.5PF B	
C440			CC73HCH1H060B	CHIP C 6.0PF B		C518			CC73HCH1H010B	CHIP C 1.0PF B	
C441			CC73HCH1H120J	CHIP C 12PF J		C519-522			CK73HB1H102K	CHIP C 1000PF K	
C442			CK73HB1A104K	CHIP C 0.10UF K		C523			CC73GCH1H101J	CHIP C 100PF J	
C443			CK73HB1H471K	CHIP C 470PF K		C524			CK73HB1H561K	CHIP C 560PF K	
C444			CK73HB1C103K	CHIP C 0.010UF K		C525			CK73HB1H102K	CHIP C 1000PF K	
C445			CC73HCH1H101J	CHIP C 100PF J		C527			CC73HCH1H030C	CHIP C 3.0PF C	
C446			CK73HB1A104K	CHIP C 0.10UF K		C528			CK73HB1H102K	CHIP C 1000PF K	
C447	*		CC73HCH1H1R5B	CHIP C 1.5PF B		C529			CC73HCH1H101J	CHIP C 100PF J	
C448			CK73HB1C103K	CHIP C 0.010UF K		C531			CC73HCH1H101J	CHIP C 100PF J	
C449			CK73HB1H471K	CHIP C 470PF K		C532			CC73HCH1H560J	CHIP C 56PF J	
C450			CK73HB1C103K	CHIP C 0.010UF K		C533			CC73HCH1H330J	CHIP C 33PF J	
C451			CK73HB1A104K	CHIP C 0.10UF K		C534			CC73HCH1H220J	CHIP C 22PF J	
C453			CK73HB1C103K	CHIP C 0.010UF K		C535			CC73HCH1H330J	CHIP C 33PF J	
C454,455			CK73HB1A104K	CHIP C 0.10UF K		C536			CK73HB1H102K	CHIP C 1000PF K	
C457			CK73HB1C223K	CHIP C 0.022UF K		C537			CC73HCH1H560J	CHIP C 56PF J	
C458			CK73HB1A104K	CHIP C 0.10UF K		C538			CK73HB1H102K	CHIP C 1000PF K	
C460			CK73HB1H471K	CHIP C 470PF K		C539			CC73HCH1H470J	CHIP C 47PF J	
C461,462			CK73HB1A104K	CHIP C 0.10UF K		C543			CK73HB1H102K	CHIP C 1000PF K	
						C544,545			CC73HCH1H680J	CHIP C 68PF J	

PARTS LIST

TX-RX UNIT (X57-6360-00)

Ref. No.	Address	New parts	Parts No.	Description	Destination	Ref. No.	Address	New parts	Parts No.	Description	Destination
C546-548			CK73HB1E472K	CHIP C 4700PF K		C654			CC73GCH1H150J	CHIP C 15PF J	
C549			CK73HB1H102K	CHIP C 1000PF K		C655			CK73HB1H471K	CHIP C 470PF K	
C551			CC73HCH1H560J	CHIP C 56PF J		C656,657			CK73HB1A104K	CHIP C 0.10UF K	
C552			CC73HCH1H121J	CHIP C 120PF J		C658			CC73HCH1H020B	CHIP C 2.0PF B	
C553			CC73HCH1H560J	CHIP C 56PF J		C659			CC73HCH1H090D	CHIP C 9.0PF D	
C554			CC73HCH1H270J	CHIP C 27PF J		C660			CC73GCH1H180J	CHIP C 18PF J	K
C555			CK73HB1E472K	CHIP C 4700PF K		C661,662			CK73HB1H471K	CHIP C 470PF K	K
C556			CK73HB1H102K	CHIP C 1000PF K		C663			CK73HB1C103K	CHIP C 0.010UF K	
C557			CK73HB1E472K	CHIP C 4700PF K		C664			CK73HB1H471K	CHIP C 470PF K	
C558,559			CK73HB1C103K	CHIP C 0.010UF K		C665,666			CK73HB1A104K	CHIP C 0.10UF K	
C560			CC73HCH1H050C	CHIP C 5.0PF C		C667			CK73HB1H471K	CHIP C 470PF K	
C561-563			CK73HB1H471K	CHIP C 470PF K		C668-670			CK73HB1C103K	CHIP C 0.010UF K	
C565			CC73HCH1H680J	CHIP C 68PF J	K	C672			CK73GB1H102K	CHIP C 1000PF K	
C567			CC73HCH1H101J	CHIP C 100PF J		C673,674			CK73HB1H102K	CHIP C 1000UF K	
C568-570			CK73HB1H471K	CHIP C 470PF K		C675			CK73GB1H471K	CHIP C 470PF K	
C571			CC73HCH1H030C	CHIP C 3.0PF C	K	C676			CK73GB1H102K	CHIP C 1000PF K	
C571			CC73HCH1H050C	CHIP C 5.0PF C	T,E	C677			CK73HB1H102K	CHIP C 1000PF K	
C575,576			CK73HB1H102K	CHIP C 1000PF K		C678,679			CK73HB1H471K	CHIP C 470PF K	K
C577			CC73HCH1H220J	CHIP C 22PF J		C680,681			CK73GB1H102K	CHIP C 1000PF K	
C578			CC73HCH1H150J	CHIP C 15PF J	K	C701			CK73GB1A224K	CHIP C 0.22UF K	
C579			CC73HCH1H220J	CHIP C 22PF J		C702,703			CK73HB1A104K	CHIP C 0.10UF K	
C580			CC73GCH1H180J	CHIP C 18PF J	K	C704			CK73HB1H392K	CHIP C 3900PF K	
C582			CK73HB1H102K	CHIP C 1000PF K		C705			CK73GB0J105K	CHIP C 1.0UF K	
C584			CC73GCH1H470J	CHIP C 47PF J	K	C706			C92-0772-05	CHIP-TAN 10UF 6.3WV	
C585			CC73GCH1H150J	CHIP C 15PF J	K	C707			C92-0656-05	CHIP-TAN 2.2UF 6.3WV	
C587			CK73GB1H102K	CHIP C 1000PF K		C709			C92-0656-05	CHIP-TAN 2.2UF 6.3WV	
C588			CK73HB1H102K	CHIP C 1000PF K		C710			CK73HB1H471K	CHIP C 470PF K	
C589			CC73GCH1H470J	CHIP C 47PF J	K	C711			CC73HCH1H151J	CHIP C 150PF J	
C592			CC73HCH1H040C	CHIP C 4.7PF C		C712			CK73HB1H471K	CHIP C 470PF K	
C596			CC73HCH1H121J	CHIP C 120PF J		C713			CK73FB0J475K	CHIP C 4.7UF K	
C597			CK73HB1A104K	CHIP C 0.10UF K		C714			CK73HB1A104K	CHIP C 0.10UF K	
C611			CK73HB1E472K	CHIP C 4700PF K		C715			CK73HB1C103K	CHIP C 0.010UF K	
C616			CK73HB1A104K	CHIP C 0.10UF K		C716			CK73HB1H182K	CHIP C 1800PF K	
C618			CC73HCH1H390J	CHIP C 39PF J		C717			CK73HB1C822K	CHIP C 8200PF K	
C619			CC73HCH1H180J	CHIP C 18PF J		C718			CK73HB1H332K	CHIP C 3300PF K	
C620			CC73HCH1H220J	CHIP C 22PF J		C719			CK73HB1A473K	CHIP C 0.047UF K	
C621			CC73HCH1H150J	CHIP C 15PF J		C720,721			CK73GB0J105K	CHIP C 1.0UF K	
C624		*	CC73HCH1H100C	CHIP C 10PF C		C722			CK73HB1H681K	CHIP C 680PF K	
C625			CC73HCH1H471K	CHIP C 470PF K		C723			C92-0766-05	CHIP-TAN 4.7UF 6.3WV	
C626			CC73HCH1H121J	CHIP C 120PF J		C724			CC73HCH1H470J	CHIP C 47PF J	
C627			CK73GB1H102K	CHIP C 1000PF K		C725			CK73HB1H471K	CHIP C 470PF K	
C628			CK73HB1A104K	CHIP C 0.10UF K		C726			CC73GCH1H221J	CHIP C 220PF J	
C630			CC73HCH1H470J	CHIP C 47PF J		C727			CC73HCH1H060B	CHIP C 6.0PF B	
C631			CK73HB1H102K	CHIP C 1000PF K		C728			CC73HCH1H220J	CHIP C 22PF J	
C632			C92-0772-05	CHIP-TAN 10UF 6.3WV		C729			CC73HCH1H180J	CHIP C 18PF J	
C634,635			CK73HB1H102K	CHIP C 1000PF K		C730			CK73HB1H102K	CHIP C 1000PF K	
C636			CC73HCH1H030C	CHIP C 3.0PF C		C732			CK73HB1C103K	CHIP C 0.010UF K	
C637,638			CC73HCH1H040C	CHIP C 4.0PF C		C733			CK73HB1E472K	CHIP C 4700PF K	
C640-643			CK73HB1H471K	CHIP C 470PF K		C734			CK73HB1H471K	CHIP C 470PF K	
C644			CC73HCH1H010B	CHIP C 1.0PF B		C735			C92-0628-05	CHIP-TAN 10UF 10WV	
C645		*	CC73HCH1H100C	CHIP C 10PF C		C737			CK73GB0J105K	CHIP C 1.0UF K	
C646			CK73HB1H471K	CHIP C 470PF K		C738			CK73HB1C103K	CHIP C 0.010UF K	
C647			CK73HB1C103K	CHIP C 0.010UF K		C739			CK73HB1H332K	CHIP C 3300PF K	
C648		*	CC73HCH1H100C	CHIP C 10PF C		C740			CK73HB1A104K	CHIP C 0.10UF K	
C652			CK73HB1H471K	CHIP C 470PF K	K	C741			CK73HB1H471K	CHIP C 470PF K	
C653			CK73HB1H471K	CHIP C 470PF K		C742			CC73HCH1H101J	CHIP C 100PF J	

TH-F6A/F7E

PARTS LIST

TX-RX UNIT (X57-6360-00)

Ref. No.	Address	New parts	Parts No.	Description	Destination	Ref. No.	Address	New parts	Parts No.	Description	Destination
C743			C92-0628-05	CHIP-TAN 10UF 10WV		C825,826			CK73HB1H471K	CHIP C 470PF K	
C744,745			CK73HB1H471K	CHIP C 470PF K		C827,828			CK73HB1C103K	CHIP C 0.010UF K	
C746			CK73GB0J105K	CHIP C 1.0UF K		C829			CK73HB1H471K	CHIP C 470PF K	
C747			CK73HB1H471K	CHIP C 470PF K		C831			CC73HCH1H470J	CHIP C 47PF J	
C748		*	C92-0786-05	CHIP-TAN 100UF 6.3WV		C832,833			CK73HB1H471K	CHIP C 470PF K	
C749,750			CK73HB1H471K	CHIP C 470PF K		C834			CK73HB1C103K	CHIP C 0.010UF K	
C751			CK73GB0J105K	CHIP C 1.0UF K		C835			CK73HB1H471K	CHIP C 470PF K	
C752			CK73HB1H471K	CHIP C 470PF K		C836			CK73GB0J105K	CHIP C 1.0UF K	
C753			CK73GB0J105K	CHIP C 1.0UF K		C837,838			CK73HB1A104K	CHIP C 0.10UF K	
C754-758			CK73HB1H471K	CHIP C 470PF K		C839			CK73GB0J105K	CHIP C 1.0UF K	
C759			CK73HB1A104K	CHIP C 0.10UF K		C841-843			CK73HB1A104K	CHIP C 0.10UF K	
C760			CK73HB1H471K	CHIP C 470PF K		C844,845			CK73FB0J475K	CHIP C 4.7UF K	
C761			CK73GB0J105K	CHIP C 1.0UF K		C846			CC73HCH1H101J	CHIP C 100PF J	
C762			CK73HB1A104K	CHIP C 0.10UF K		C847			CK73GB0J105K	CHIP C 1.0UF K	
C763			CK73HB1H471K	CHIP C 470PF K		C848			C92-0628-05	CHIP-TAN 10UF 10WV	
C764			CK73HB1C103K	CHIP C 0.010UF K		C849			C92-0792-05	CHIP-TAN	
C765			CK73HB1H471K	CHIP C 470PF K		C852			CK73HB1A104K	CHIP C 0.10UF K	
C766		*	C92-0786-05	CHIP-TAN 100UF 6.3WV		C853			C92-0656-05	CHIP-TAN 2.2UF 6.3WV	
C767			CK73HB1H471K	CHIP C 470PF K		C870			CK73HB1H471K	CHIP C 470PF K	
C768			CK73HB1A104K	CHIP C 0.10UF K		C871			CK73GB0J105K	CHIP C 1.0UF K	
C769			CK73HB1H471K	CHIP C 470PF K		C872			CK73HB1E682K	CHIP C 6800PF K	
C770			CC73HCH1H470J	CHIP C 47PF J		C873			CK73HB1C223K	CHIP C 0.022UF K	
C771			CK73HB1A333K	CHIP C 0.033UF K		C874			CC73HCH1H680J	CHIP C 68PF J	
C772			C92-0656-05	CHIP-TAN 2.2UF 6.3WV		C875			CK73HB1H221K	CHIP C 220PF K	
C773			CC73HCH1H121J	CHIP C 120PF J		C876			C92-0772-05	CHIP-TAN 10UF 6.3WV	
C774			CK73HB1C103K	CHIP C 0.010UF K		C878			CK73FB0J475K	CHIP C 4.7UF K	
C775			CK73HB1H222K	CHIP C 2200PF K		C879			CK73GB1A474K	CHIP C 0.47UF K	
C776			CK73HB1C123K	CHIP C 0.012UF K		C880			C92-0772-05	CHIP-ELECTR 470UF 10WV	
C777			CK73HB1A473K	CHIP C 0.047UF K		C881			CK73GB1C104K	CHIP C 0.1UF K	
C778			CK73HB1A104K	CHIP C 0.10UF K		C882			CK73HB1H471K	CHIP C 470PF K	
C780			CK73HB1A104K	CHIP C 0.10UF K		C883			CK73HB1A104K	CHIP C 0.1UF K	
C781			CK73GB0J105K	CHIP C 1.0UF K		C884			CK73HB1H102K	CHIP C 0.1UF K	
C782			CK73HB1H332K	CHIP C 3300PF K		C885			C92-0792-05	CHIP-TAN 330UF 25WV	
C783,784		*	C92-0786-05	CHIP-TAN 100UF 6.3WV					E23-1059-04	TERMINAL	
C787			CK73GB0J105K	CHIP C 1.0UF K		CN7		*	E40-6171-05	PIN ASSY	
C788			CK73HB1A104K	CHIP C 0.10UF K		CN8		*	E40-6215-05	PIN ASSY	
C789			CK73HB1E682K	CHIP C 6800PF K		CN9		*	E40-6216-05	PIN ASSY SOCKET	
C791			CK73GB0J105K	CHIP C 1.0UF K		CN713			E40-5972-05	FLAT CABLE CONNECTOR	
C792,793			CK73HB1A333K	CHIP C 0.033UF K					E40-5915-05	FLAT CABLE CONNECTOR	
C794			CK73GB1A224K	CHIP C 0.22UF K		CN714			E40-5929-05	PIN ASSY	
C795			CK73HB1A104K	CHIP C 0.10UF K		CN715			E40-6172-05	PIN ASSY SOCKET	
C796			CK73GB0J105K	CHIP C 1.0UF K		CN716		*	E03-0190-05	DC JACK	
C797			CK73HB1C223K	CHIP C 0.022UF K		J1			E11-0457-05	PHONE JACK (2.5D/3.5D)	
C798,799			CK73HB1H102K	CHIP C 1000PF K		J701					
C800-802			CK73HB1H471K	CHIP C 470PF K		54	-	*	F01-1019-14	RADIATION PLATE	
C803			CK73HB1H102K	CHIP C 1000PF K		55	2B	*	F10-2423-04	SHIELDING PLATE	
C804			CK73HB1H471K	CHIP C 470PF K		56	-	*	F10-2426-04	SHIELDING COVER	
C805,806			CK73FB0J475K	CHIP C 4.7UF K		F1			F53-0190-05	FUSE	
C807			CK73HB1H471K	CHIP C 470PF K		F2			F53-0246-05	FUSE	
C808			CK73FB0J475K	CHIP C 4.7UF K		F3			F53-0245-05	FUSE	
C809			CK73GB1A474K	CHIP C 0.47UF K		CD1			L79-1474-05	TUNING COIL	
C810			CK73GB0J105K	CHIP C 1.0UF K		CF1		*	L72-0991-05	CERAMIC FILTER	
C811-819			CK73HB1A104K	CHIP C 0.10UF K		CF2			L72-0957-05	CERAMIC FILTER	
C820			C92-0628-05	CHIP-TAN 10UF 10WV		CF3		*	L72-0990-05	CERAMIC FILTER	
C822			CK73HB1A473K	CHIP C 0.047UF K		CF4		*	L72-0989-05	CERAMIC FILTER	
C823,824			CK73FB0J475K	CHIP C 4.7UF K		CF5			L72-0957-05	CERAMIC FILTER	

PARTS LIST

TX-RX UNIT (X57-6360-00)

Ref. No.	Address	New parts	Parts No.	Description	Destination	Ref. No.	Address	New parts	Parts No.	Description	Destination
L1,2			L40-1091-86	SMALL FIXED INDUCTOR(1.0U)		L96		*	L41-1575-01	SMALL FIXED INDUCTOR	T,E
L3			L92-0149-05	FERRITE CHIP		L96		*	L41-2275-01	SMALL FIXED INDUCTOR	K
L5		*	L41-1278-14	SMALL FIXED INDUCTOR		L97		*	L41-1085-03	SMALL FIXED INDUCTOR	T,E
L6		*	L41-3978-14	SMALL FIXED INDUCTOR		L97		*	L41-8275-03	SMALL FIXED INDUCTOR	K
L7		*	L41-2778-14	SMALL FIXED INDUCTOR		L98		*	L41-5675-03	SMALL FIXED INDUCTOR	
L8		*	L41-1878-14	SMALL FIXED INDUCTOR		L99		*	L41-1575-01	SMALL FIXED INDUCTOR	
L9,10			L40-2291-37	SMALL FIXED INDUCTOR(2.200UH)		L101		*	L41-4775-03	SMALL FIXED INDUCTOR	
L13			L40-1275-71	SMALL FIXED INDUCTOR(12NH)		L102		*	L41-8278-14	SMALL FIXED INDUCTOR	
L18		*	L34-4659-05	COIL		L104,105		*	L41-1085-14	SMALL FIXED INDUCTOR	
L19		*	L34-4660-05	COIL		L106		*	L41-2775-03	SMALL FIXED INDUCTOR	
L21,22			L40-5681-86	SMALL FIXED INDUCTOR(0.56U)		L108			L92-0161-05	BEADS CORE	
L23		*	L40-4788-76	SMALL FIXED INDUCTOR(0.47UH)		L109		*	L41-6875-03	SMALL FIXED INDUCTOR	
L26			L40-6881-37	SMALL FIXED INDUCTOR(0.680UH)		L110		*	L41-1085-03	SMALL FIXED INDUCTOR	
L27		*	L41-5678-14	SMALL FIXED INDUCTOR		L111,112			L40-1885-92	SMALL FIXED INDUCTOR(180NH)	
L28			L40-2291-37	SMALL FIXED INDUCTOR(2.200UH)		L115		*	L41-1285-03	SMALL FIXED INDUCTOR	
L29		*	L41-2778-14	SMALL FIXED INDUCTOR		L116,117		*	L41-1085-03	SMALL FIXED INDUCTOR	
L30		*	L41-5678-14	SMALL FIXED INDUCTOR		L121		*	L40-3975-92	SMALL FIXED INDUCTOR	
L31			L40-2291-37	SMALL FIXED INDUCTOR(2.200UH)		L123		*	L40-3975-71	SMALL FIXED INDUCTOR(39NH)	
L32		*	L41-1578-14	SMALL FIXED INDUCTOR		L124			L40-2285-54	SMALL FIXED INDUCTOR(220NH)	K
L34			L40-5668-71	SMALL FIXED INDUCTOR(5.6NH)		L125			L34-1230-05	AIR-CORE COIL	K
L35			L40-2275-71	SMALL FIXED INDUCTOR(22NH)		L126			L34-4573-05	AIR-CORE COIL	K
L36			L40-5681-86	SMALL FIXED INDUCTOR(0.56U)		L128			L40-1098-76	SMALL FIXED INDUCTOR(1UH)	
L38			L40-4781-86	SMALL FIXED INDUCTOR(0.47U)		L131		*	L41-8275-03	SMALL FIXED INDUCTOR	
L42			L34-1230-05	AIR-CORE COIL		L132		*	L41-1278-14	SMALL FIXED INDUCTOR	
L44			L40-1275-71	SMALL FIXED INDUCTOR(12NH)		L133		*	L34-4690-05	AIR-CORE COIL	
L45			L34-4577-05	AIR-CORE COIL		L134		*	L41-1885-03	SMALL FIXED INDUCTOR	
L46			L34-4566-05	AIR-CORE COIL		L138		*	L41-5675-01	SMALL FIXED INDUCTOR	
L48			L34-1230-05	AIR-CORE COIL		L141			L40-1275-71	SMALL FIXED INDUCTOR(12NH)	
L49			L40-3975-92	SMALL FIXED INDUCTOR		L142			L40-6865-71	SMALL FIXED INDUCTOR(18NH)	
L50			L40-4775-76	SMALL FIXED INDUCTOR		L146			L40-2285-54	SMALL FIXED INDUCTOR(220NH)	
L56			L34-4577-05	AIR-CORE COIL	K	L151-154			L92-0161-05	BEADS CORE	
L58			L34-4575-05	AIR-CORE COIL	T,E	L157		*	L34-4576-05	AIR-CORE COIL	K
L58			L34-4577-05	AIR-CORE COIL	K	L159			L40-1075-71	SMALL FIXED INDUCTOR(10NH)	K
L59			L40-1005-85	SMALL FIXED INDUCTOR(220U)		L160			L40-1875-71	SMALL FIXED INDUCTOR(18NH)	
L60			L34-4573-05	AIR-CORE COIL	K	L161		*	L41-4775-03	SMALL FIXED INDUCTOR	
L61			L40-1085-54	SMALL FIXED INDUCTOR(100NH)		L162		*	L41-1085-03	SMALL FIXED INDUCTOR	
L63			L34-4572-05	AIR-CORE COIL		L163		*	L41-4775-03	SMALL FIXED INDUCTOR	
L65			L34-4572-05	AIR-CORE COIL		L164		*	L41-2775-03	SMALL FIXED INDUCTOR	
L67			L34-4572-05	AIR-CORE COIL		L165		*	L41-1875-03	SMALL FIXED INDUCTOR	
L68,69		*	L34-4576-05	AIR-CORE COIL		L167		*	L41-3378-14	SMALL FIXED INDUCTOR	
L75		*	L34-4576-05	AIR-CORE COIL		L168,169			L40-3391-86	SMALL FIXED INDUCTOR(3.3U)	
L77			L34-4574-05	AIR-CORE COIL		L172		*	L41-8275-03	SMALL FIXED INDUCTOR	
L78			L34-4572-05	AIR-CORE COIL		L173		*	L41-1285-03	SMALL FIXED INDUCTOR	
L79		*	L34-4689-05	AIR-CORE COIL		L176		*	L92-0163-05	BEADS CORE	
L80		*	L41-8268-14	SMALL FIXED INDUCTOR		L177		*	L41-2761-01	SMALL FIXED INDUCTOR	
L81		*	L41-1278-14	SMALL FIXED INDUCTOR		L179			L40-6881-37	SMALL FIXED INDUCTOR(0.680UH)	
L89		*	L41-1575-01	SMALL FIXED INDUCTOR	T,E	L180			L40-4768-71	SMALL FIXED INDUCTOR(4.7NH)	
L90		*	L41-1075-01	SMALL FIXED INDUCTOR	K	L181			L40-1875-71	SMALL FIXED INDUCTOR(18NH)	
L90		*	L41-1875-01	SMALL FIXED INDUCTOR	T,E	L182			L40-2285-92	SMALL FIXED INDUCTOR(220NH)	
L91		*	L41-2775-01	SMALL FIXED INDUCTOR	T,E	L183			L40-2781-37	SMALL FIXED INDUCTOR(0.270UH)	
L91		*	L41-3975-01	SMALL FIXED INDUCTOR	K	L184			L40-3381-37	SMALL FIXED INDUCTOR(0.330UH)	
L92			L79-1525-05	FILTER MODULE	T,E	L185			L40-1075-71	SMALL FIXED INDUCTOR(10NH)	
L92			L79-1526-05	FILTER MODULE	K	L186			L40-1091-37	SMALL FIXED INDUCTOR(1.000UH)	
L93		*	L41-2775-01	SMALL FIXED INDUCTOR	T,E	L187			L40-4768-71	SMALL FIXED INDUCTOR(4.7NH)	
L93		*	L41-3975-01	SMALL FIXED INDUCTOR	K	L188		*	L41-1875-03	SMALL FIXED INDUCTOR	K
L94,95		*	L41-1875-01	SMALL FIXED INDUCTOR		L190			L40-2775-71	SMALL FIXED INDUCTOR(27NH)	K

TH-F6A/F7E

PARTS LIST

TX-RX UNIT (X57-6360-00)

Ref. No.	Address	New parts	Parts No.	Description	Destination	Ref. No.	Address	New parts	Parts No.	Description	Destination
L191			L40-1091-37	SMALL FIXED INDUCTOR(1.000UH)		R28			RK73HB1J152J	CHIP R 1.5K J 1/16W	
L192			L40-2285-54	SMALL FIXED INDUCTOR(220NH)		R29			RK73HB1J105J	CHIP R 1.0M J 1/16W	
L193			L40-1068-71	SMALL FIXED INDUCTOR(1.0NH)		R30,31			RK73HB1J472J	CHIP R 4.7K J 1/16W	
L194		*	L40-4775-71	SMALL FIXED INDUCTOR(47NH)		R32			RK73HB1J152J	CHIP R 1.5K J 1/16W	
L195			L40-1895-85	SMALL FIXED INDUCTOR(220NH)		R33			RK73HB1J105J	CHIP R 1.0M J 1/16W	
L196			L40-8275-57	SMALL FIXED INDUCTOR		R34,35			RK73HB1J472J	CHIP R 4.7K J 1/16W	
L197			L40-3375-71	SMALL FIXED INDUCTOR		R37			RK73HB1J223J	CHIP R 22K J 1/16W	
L198			L92-0161-05	BEADS CORE		R39			RK73HB1J221J	CHIP R 220 J 1/16W	
L199			L40-1091-86	SMALL FIXED INDUCTOR		R40			RK73HB1J101J	CHIP R 100 J 1/16W	
L200			L92-0161-05	BEADS CORE		R41,42			RK73HB1J121J	CHIP R 120 J 1/16W	
L203			L92-0138-05	FERRITE CHIP		R43			RK73HB1J470J	CHIP R 47 J 1/16W	
L702			L92-0131-05	FERRITE CHIP		R44			RK73HB1J121J	CHIP R 120 J 1/16W	
L703			L92-0140-05	FERRITE CHIP		R45			RK73HB1J223J	CHIP R 22K J 1/16W	
L704,705		*	L92-0163-05	BEADS CORE		R46			RK73HB1J221J	CHIP R 220 J 1/16W	
L706			L40-3301-37	SMALL FIXED INDUCTOR		R48			RK73HB1J474J	CHIP R 470K J 1/16W	
L707,708			L92-0163-05	BEADS CORE		R51			RK73HB1J222J	CHIP R 2.2K J 1/16W	
X1		*	L77-1859-05	TCXO (19.8MHZ)		R55			RK73HB1J103J	CHIP R 10K J 1/16W	
X2		*	L78-0496-05	RESONATOR (453KHZ)		R56,57			RK73HB1J104J	CHIP R 100K J 1/16W	
X3		*	L77-1856-05	CRYSTAL RESONATOR(19.05MHZ)		R58			RK73HB1J470J	CHIP R 47 J 1/16W	
X701			L78-0462-05	RESONATOR (9.8304M)		R59			RK73HB1J471J	CHIP R 470 J 1/16W	
XF1		*	L71-0597-05	MCF (57.6MHZ)		R60			RK73HB1J222J	CHIP R 2.2K J 1/16W	
XF2		*	L71-0589-05	MCF (59.85MHZ)		R61,62			RK73HB1J104J	CHIP R 100K J 1/16W	
CP2		*	RK75HA1J392J	CHIP-COM 3.9K J 1/16W		R64			RK73HB1J470J	CHIP R 47 J 1/16W	
CP7		*	RK75HA1J103J	CHIP-COM 10K J 1/16W		R67			RK73HB1J105J	CHIP R 1.0M J 1/16W	
CP9		*	RK75HA1J392J	CHIP-COM 3.9K J 1/16W		R68			RK73HB1J474J	CHIP R 470K J 1/16W	
CP12		*	RK75HA1J392J	CHIP-COM 3.9K J 1/16W		R69			RK73HB1J562J	CHIP R 5.6K J 1/16W	
CP13		*	RK75HA1J473J	CHIP-COM 47K J 1/16W		R70			RK73HB1J474J	CHIP R 470K J 1/16W	
CP21		*	RK75HA1J473J	CHIP-COM 47K J 1/16W		R71			RK73HB1J470J	CHIP R 47 J 1/16W	
CP22		*	RK75HA1J392J	CHIP-COM 3.9K J 1/16W		R72			RK73HB1J474J	CHIP R 470K J 1/16W	
CP701-712			R90-0741-05	MULTIPLE RESISTOR		R73			RK73HB1J562J	CHIP R 5.6K J 1/16W	
CP713		*	RK75HA1J392J	CHIP-COM 3.9K J 1/16W		R74			RK73HB1J332J	CHIP R 3.3K J 1/16W	
R1			RK73HB1J102J	CHIP R 1.0K J 1/16W		R75			RK73HB1J152J	CHIP R 1.5K J 1/16W	
R2			R92-1255-05	CHIP R 15 1/2W		R76			RK73HB1J822J	CHIP R 8.2K	
R4			RK73HB1J101J	CHIP R 100 J 1/16W		R77			RK73HB1J223J	CHIP R 22K J 1/16W	
R5			RK73FB2A122J	CHIP R 1.2K J 1/10W		R79			RK73HB1J102J	CHIP R 1.0K J 1/16W	
R6			RK73HB1J104J	CHIP R 100K J 1/16W		R80			RK73HB1J271J	CHIP R 270 J 1/16W	
R7			RK73HB1J393J	CHIP R 39K J 1/16W		R81			RK73HB1J154J	CHIP R 150K J 1/16W	
R8			RK73HB1J102J	CHIP R 1.0K J 1/16W		R82			RK73HB1J471J	CHIP R 470 J 1/16W	
R9			RK73HB1J124J	CHIP R 120K J 1/16W		R86			RK73HB1J223J	CHIP R 22K J 1/16W	
R10			RK73HB1J474J	CHIP R 470K J 1/16W		R87			RK73HB1J183J	CHIP R 18K J 1/16W	
R11			RK73HB1J180J	CHIP R 18 J 1/16W		R88			RK73HB1J272J	CHIP R 2.7K J 1/16W	
R12			RK73HB1J122J	CHIP R 1.2K J 1/16W		R89			RK73HB1J683J	CHIP R 68K J 1/16W	
R13			RK73HB1J562J	CHIP R 5.6K J 1/16W		R90			RK73HB1J331J	CHIP R 330 J 1/16W	
R14			R92-1368-05	CHIP R 0 OHM		R92			RK73HB1J153J	CHIP R 15K J 1/16W	
R15			RK73HB1J151J	CHIP R 150 J 1/16W		R93			RK73HB1J102J	CHIP R 1.0K J 1/16W	
R16			RK73HB1J562J	CHIP R 5.6K J 1/16W		R94			RK73HB1J474J	CHIP R 470K J 1/16W	
R17			RK73HB1J473J	CHIP R 47K J 1/16W		R95			RK73HB1J472J	CHIP R 4.7K J 1/16W	
R18			RK73HB1J332J	CHIP R 3.3K J 1/16W		R96			RK73HB1J104J	CHIP R 100K J 1/16W	
R19			R92-2559-05	CHIP R 12 1/2W		R97,98			RK73HB1J153J	CHIP R 15K J 1/16W	
R20			RK73HB1J152J	CHIP R 1.5K J 1/16W		R102			RK73HB1J101J	CHIP R 100 J 1/16W	
R21			RK73HB1J104J	CHIP R 100K J 1/16W		R103			RK73HB1J224J	CHIP R 220K J 1/16W	
R22			RK73HB1J152J	CHIP R 1.5K J 1/16W		R105			RK73HB1J152J	CHIP R 1.5K J 1/16W	
R23			RK73HB1J223J	CHIP R 22K J 1/16W		R106			RK73HB1J470J	CHIP R 47 J 1/16W	
R24			RK73HB1J472J	CHIP R 4.7K J 1/16W		R107			RK73HB1J101J	CHIP R 100 J 1/16W	
R26,27			RK73HB1J102J	CHIP R 1.0K J 1/16W		R109			RK73HB1J561J	CHIP R 560 J 1/16W	
						R110			RK73HB1J472J	CHIP R 4.7K J 1/16W	

PARTS LIST

TX-RX UNIT (X57-6360-00)

Ref. No.	Address	New parts	Parts No.	Description	Destination	Ref. No.	Address	New parts	Parts No.	Description	Destination
R112			RK73HB1J473J	CHIP R 47K J 1/16W		R191,192			RK73HB1J222J	CHIP R 2.2K J 1/16W	
R113			RK73HB1J102J	CHIP R 1.0K J 1/16W		R193			RK73HB1J101J	CHIP R 100 J 1/16W	
R114			RK73HB1J332J	CHIP R 3.3K J 1/16W		R194			RK73HB1J334J	CHIP R 330K J 1/16W	
R115			RK73HB1J104J	CHIP R 100K J 1/16W		R195			RK73HB1J181J	CHIP R 180 J 1/16W	
R116			RK73HB1J471J	CHIP R 470 J 1/16W		R196			RK73HB1J334J	CHIP R 330K J 1/16W	
R119			RK73HB1J331J	CHIP R 330 J 1/16W		R197			RK73HB1J470J	CHIP R 47 J 1/16W	
R122			RK73HB1J562J	CHIP R 5.6K J 1/16W		R198			RK73HB1J102J	CHIP R 1.0K J 1/16W	
R124			RK73HB1J105J	CHIP R 1.0M J 1/16W		R199			RK73HB1J181J	CHIP R 180 J 1/16W	
R125			RK73HB1J224J	CHIP R 220K J 1/16W		R200			RK73HB1J184J	CHIP R 180K J 1/16W	
R126			RK73HB1J331J	CHIP R 330 J 1/16W		R201			RK73HB1J102J	CHIP R 1.0K J 1/16W	
R128			RK73HB1J104J	CHIP R 100K J 1/16W		R202			RK73HB1J224J	CHIP R 220K J 1/16W	
R129			RK73HB1J470J	CHIP R 47 J 1/16W		R203			RK73HB1J472J	CHIP R 4.7K J 1/16W	
R130			RK73HB1J101J	CHIP R 100 J 1/16W		R204	*		R92-3512-05	CARBON RESISTOR0.1 1/2W	
R131			RK73HB1J123J	CHIP R 12K J 1/16W		R206	*		R92-3512-05	CARBON RESISTOR0.1 1/2W	
R134,135			RK73HB1J102J	CHIP R 1.0K J 1/16W		R207			RK73HB1J222J	CHIP R 2.2K J 1/16W	
R136,137			RK73HB1J333J	CHIP R 33K J 1/16W		R208			RK73HB1J473J	CHIP R 47K J 1/16W	
R138			RK73HB1J681J	CHIP R 680 J 1/16W		R209			RK73HB1J222J	CHIP R 2.2K J 1/16W	
R139			RK73HB1J151J	CHIP R 150 J 1/16W		R210			RK73HB1J473J	CHIP R 47K J 1/16W	
R140			RK73HB1J121J	CHIP R 120 J 1/16W		R211			RK73HB1J104J	CHIP R 100K J 1/16W	
R141			R92-1368-05	CHIP R 0 OHM		R212			RK73HB1J273J	CHIP R 27K J 1/16W	
R142			RK73HB1J103J	CHIP R 10K J 1/16W		R213			RK73HB1J101J	CHIP R 100 J 1/16W	
R143			RK73HB1J102J	CHIP R 1.0K J 1/16W		R214			RK73HB1J474J	CHIP R 470K J 1/16W	
R144			RK73HB1J124J	CHIP R 120K J 1/16W		R220			RK73HB1J224J	CHIP R 220K J 1/16W	
R145			RK73HB1J180J	CHIP R 18 J 1/16W		R221			RK73HB1J222J	CHIP R 2.2K J 1/16W	
R146			RK73HB1J332J	CHIP R 3.3K J 1/16W		R222			RK73HB1J100J	CHIP R 10 J 1/16W	
R147-149			RK73HB1J152J	CHIP R 1.5K J 1/16W		R224			RK73HB1J470J	CHIP R 47 J 1/16W	
R151			RK73HB1J562J	CHIP R 5.6K J 1/16W		R225			RK73HB1J223J	CHIP R 22K J 1/16W	
R152			RK73HB1J104J	CHIP R 100K J 1/16W		R226			RK73HB1J473J	CHIP R 47K J 1/16W	
R153			RK73HB1J102J	CHIP R 1.0K J 1/16W		R227			RK73HB1J222J	CHIP R 2.2K J 1/16W	
R154			RK73HB1J152J	CHIP R 1.5K J 1/16W		R228			RK73HB1J470J	CHIP R 47 J 1/16W	
R156			RK73HB1J472J	CHIP R 4.7K J 1/16W		R229			RK73HB1J473J	CHIP R 47K J 1/16W	
R157			RK73HB1J562J	CHIP R 5.6K J 1/16W		R232			RK73HB1J222J	CHIP R 2.2K J 1/16W	
R158			RK73HB1J472J	CHIP R 4.7K J 1/16W		R233			RK73HB1J101J	CHIP R 100 J 1/16W	K
R159			RK73HB1J271J	CHIP R 270 J 1/16W		R234			RK73HB1J473J	CHIP R 47K J 1/16W	
R160			RK73HB1J121J	CHIP R 120 J 1/16W		R236			RK73HB1J680J	CHIP R 68 J 1/16W	
R162			RK73HB1J472J	CHIP R 4.7K J 1/16W		R237			RK73HB1J390J	CHIP R 39 J 1/16W	
R163			RK73HB1J101J	CHIP R 100 J 1/16W		R239,240			RK73HB1J560J	CHIP R 56 J 1/16W	
R164			RK73HB1J222J	CHIP R 2.2K J 1/16W		R242			RK73HB1J560J	CHIP R 56 J 1/16W	
R165			R92-1368-05	CHIP R 0 OHM		R243,244			RK73HB1J332J	CHIP R 3.3K J 1/16W	
R166			RK73HB1J563J	CHIP R 56K J 1/16W		R245			RK73HB1J473J	CHIP R 47K J 1/16W	
R167			RK73HB1J101J	CHIP R 100 J 1/16W		R246			RK73HB1J682J	CHIP R 6.8K J 1/16W	
R168			RK73HB1J222J	CHIP R 2.2K J 1/16W		R248			RK73HB1J471J	CHIP R 470 J 1/16W	
R170			RK73HB1J473J	CHIP R 47K J 1/16W		R249			RK73HB1J100J	CHIP R 10 J 1/16W	
R172			RK73HB1J100J	CHIP R 10 J 1/16W		R251			RK73HB1J154J	CHIP R 150K J 1/16W	
R177			RK73HB1J183J	CHIP R 18K J 1/16W		R252-256			RK73HB1J104J	CHIP R 100K J 1/16W	
R178			RK73HB1J221J	CHIP R 220 J 1/16W		R257			RK73HB1J392J	CHIP R 3.9K J 1/16W	
R179			RK73HB1J101J	CHIP R 100 J 1/16W		R264			RK73HB1J332J	CHIP R 3.3K J 1/16W	
R181			RK73HB1J223J	CHIP R 22K J 1/16W		R267			RK73HB1J470J	CHIP R 47 J 1/16W	
R182			RK73HB1J221J	CHIP R 220 J 1/16W		R269			RK73HB1J104J	CHIP R 100K J 1/16W	
R183			RK73HB1J222J	CHIP R 2.2K J 1/16W		R270			R92-1368-05	CHIP R 0 OHM	
R184			RK73HB1J561J	CHIP R 560 J 1/16W		R271			RK73HB1J682J	CHIP R 6.8K J 1/16W	
R185			RK73HB1J273J	CHIP R 27K J 1/16W		R272			RK73HB1J332J	CHIP R 3.3K J 1/16W	
R186			RK73HB1J182J	CHIP R 1.8K J 1/16W		R273			RK73HB1J101J	CHIP R 100 J 1/16W	
R188			RK73HB1J152J	CHIP R 1.5K J 1/16W		R274			RK73HB1J470J	CHIP R 47 J 1/16W	
R189			R92-1368-05	CHIP R 0 OHM		R275			RK73HB1J222J	CHIP R 2.2K J 1/16W	
R190			RK73HB1J474J	CHIP R 470K J 1/16W		R278			RK73HB1J104J	CHIP R 100K J 1/16W	

TH-F6A/F7E

PARTS LIST

TX-RX UNIT (X57-6360-00)

Ref. No.	Address	New parts	Parts No.	Description	Destination	Ref. No.	Address	New parts	Parts No.	Description	Destination
R279			RK73HB1J105J	CHIP R 1.0M J 1/16W		R375			RK73HB1J473J	CHIP R 47K J 1/16W	
R280			RK73HB1J682J	CHIP R 6.8K J 1/16W		R376,377			RK73HB1J103J	CHIP R 10K J 1/16W	
R281			RK73HB1J105J	CHIP R 1.0M J 1/16W		R378			RK73HB1J333J	CHIP R 33K J 1/16W	
R282			RK73HB1J332J	CHIP R 3.3K J 1/16W		R379			RK73HB1J103J	CHIP R 10K J 1/16W	
R284			RK73HB1J100J	CHIP R 10 J 1/16W		R381			RK73HB1J470J	CHIP R 47 J 1/16W	
R285			RK73HB1J103J	CHIP R 10K J 1/16W		R382			RK73HB1J103J	CHIP R 10K J 1/16W	
R286			RK73HB1J105J	CHIP R 1.0M J 1/16W		R384			RK73HB1J103J	CHIP R 10K J 1/16W	
R287			RK73HB1J332J	CHIP R 3.3K J 1/16W		R387			R92-1368-05	CHIP R 0 OHM	
R288			R92-1368-05	CHIP R 0 OHM		R390			RK73HB1J153J	CHIP R 15K J 1/16W	
R291			R92-1368-05	CHIP R 0 OHM		R391			R92-1368-05	CHIP R 0 OHM	
R292			RK73HB1J470J	CHIP R 47 J 1/16W		R392			RK73HB1J123J	CHIP R 12K J 1/16W	
R293			RK73HB1J104J	CHIP R 100K J 1/16W		R394			RK73HB1J472J	CHIP R 4.7K J 1/16W	
R294			RK73HB1J104J	CHIP R 100K J 1/16W		R396			RK73HB1J472J	CHIP R 4.7K J 1/16W	
R297			RK73HB1J223J	CHIP R 22K J 1/16W		R397			RK73HB1J151J	CHIP R 150 J 1/16W	
R298			RK73HB1J273J	CHIP R 27K J 1/16W		R398			RK73HB1J103J	CHIP R 10K J 1/16W	
R299			R92-1368-05	CHIP R 0 OHM		R399			RK73HB1J101J	CHIP R 100 J 1/16W	
R300-303			RK73HB1J392J	CHIP R 3.9K J 1/16W		R400			R92-1368-05	CHIP R 0 OHM	
R304			RK73HB1J152J	CHIP R 1.5K J 1/16W		R401			RK73HB1J102J	CHIP R 1.0K J 1/16W	
R305,306			RK73HB1J101J	CHIP R 100 J 1/16W		R402			RK73HB1J333J	CHIP R 33K J 1/16W	
R307,308			RK73HB1J473J	CHIP R 47K J 1/16W		R403			RK73HB1J151J	CHIP R 150 J 1/16W	
R309			RK73HB1J392J	CHIP R 3.9K J 1/16W		R404			RK73HB1J103J	CHIP R 10K J 1/16W	
R310-312			RK73HB1J332J	CHIP R 3.3K J 1/16W		R406			R92-1252-05	CHIP R 0 OHM	T,E
R313,314			RK73HB1J101J	CHIP R 100 J 1/16W		R407			RK73HB1J102J	CHIP R 1K J 1/16W	
R315			RK73HB1J332J	CHIP R 3.3K J 1/16W		R408			RK73HB1J152J	CHIP R 1.5K J 1/16W	
R317			RK73HB1J332J	CHIP R 3.3K J 1/16W		R409			RK73HB1J102J	CHIP R 1.0K J 1/16W	
R318,319			RK73HB1J473J	CHIP R 47K J 1/16W		R410			R92-1368-05	CHIP R 0 OHM	
R320			RK73HB1J472J	CHIP R 4.7K J 1/16W		R411			RK73HB1J104J	CHIP R 100K J 1/16W	
R321			RK73HB1J474J	CHIP R 470K J 1/16W		R412,413			RK73HB1J181J	CHIP R 180 J 1/16W	K
R322			RK73HB1J100J	CHIP R 10 J 1/16W		R414			RK73HB1J684J	CHIP R 680K J 1/16W	
R324			RK73HB1J103J	CHIP R 10K J 1/16W		R415			RK73HB1J102J	CHIP R 1.0K J	
R326			RK73HB1J221J	CHIP R 220 J 1/16W		R416			RK73HB1J332J	CHIP R 3.3K J 1/16W	
R327			RK73HB1J102J	CHIP R 1.0K J 1/16W		R417			RK73HB1J104J	CHIP R 100K J 1/16W	
R329			RK73HB1J220J	CHIP R 22 J 1/16W		R418			RK73HB1J103J	CHIP R 10K J 1/16W	
R331			RK73HB1J101J	CHIP R 100 J 1/16W		R420,421			RK73HB1J474J	CHIP R 470K J 1/16W	
R332			RK73HB1J223J	CHIP R 22K J 1/16W		R422,423			RK73HB1J103J	CHIP R 10K J 1/16W	
R333			RK73HB1J682J	CHIP R 6.8K J 1/16W		R425			R92-1252-05	CHIP R 0 OHM	
R334			RK73HB1J101J	CHIP R 100 J 1/16W		R426			RK73HB1J102J	CHIP R 1.0K J 1/16W	
R336			RK73HB1J470J	CHIP R 47 J 1/16W		R427			R92-1368-05	CHIP R 0 OHM	
R337			RK73HB1J104J	CHIP R 100K J 1/16W		R701			R92-1252-05	CHIP R 0 OHM	
R339			RK73HB1J104J	CHIP R 100K J 1/16W		R702			RK73HB1J824J	CHIP R 820K J 1/16W	
R340			RK73HB1J102J	CHIP R 1.0K J 1/16W		R703			RK73HB1J224J	CHIP R 220K J 1/16W	
R341			RK73HB1J332J	CHIP R 3.3K J 1/16W		R704			RK73HB1J561J	CHIP R 560 J 1/16W	
R343			RK73HB1J470J	CHIP R 470 J 1/16W		R705			RK73HB1J101J	CHIP R 100 J 1/16W	
R347-350			RK73HB1J473J	CHIP R 47K J 1/16W		R706,707			RK73HB1J473J	CHIP R 47K J 1/16W	
R351			RK73HB1J103J	CHIP R 10K J 1/16W		R708			RK73HB1J393J	CHIP R 39K J 1/16W	
R352			RK73HB1J473J	CHIP R 47K J 1/16W		R709			RK73HB1J273J	CHIP R 27K J 1/16W	
R353			RK73HB1J472J	CHIP R 4.7K J 1/16W		R710			RK73HB1J103J	CHIP R 10K J 1/16W	
R354			RK73HB1J104J	CHIP R 100K J 1/16W		R711			RK73HB1J472J	CHIP R 4.7K J 1/16W	
R356			RK73HB1J104J	CHIP R 100K J 1/16W		R712			RK73HB1J222J	CHIP R 2.2K J 1/16W	
R357			RK73HB1J223J	CHIP R 22K J 1/16W		R713			RK73HB1J391J	CHIP R 390 J 1/16W	
R359			RK73HB1J332J	CHIP R 3.3K J 1/16W		R714			RK73HB1J474J	CHIP R 470K J 1/16W	
R360			RK73HB1J152J	CHIP R 1.5K J 1/16W		R715			RK73HB1J103J	CHIP R 10K J 1/16W	
R361			RK73HB1J332J	CHIP R 3.3K J 1/16W		R716			RK73HB1J472J	CHIP R 4.7K J 1/16W	
R365			RK73HB1J105J	CHIP R 1.0M J 1/16W		R717			RK73HB1J103J	CHIP R 10K J 1/16W	
R366			R92-1368-05	CHIP R 0 OHM		R718,719			RK73HB1J104J	CHIP R 100K J 1/16W	
R373,374			R92-1368-05	CHIP R 0 OHM		R720			RK73HB1J824J	CHIP R 820K J 1/16W	

PARTS LIST

TX-RX UNIT (X57-6360-00)

Ref. No.	Address	New parts	Parts No.	Description	Destination	Ref. No.	Address	New parts	Parts No.	Description	Destination
R721			RK73HB1J183J	CHIP R 18K J 1/16W		R783			R92-1368-05	CHIP R 0 OHM	
R722			R92-1368-05	CHIP R 0 OHM		R784,785			RK73HB1J184J	CHIP R 180K J 1/16W	
R723			RK73HB1J824J	CHIP R 820K J 1/16W		R786			RK73HB1J473J	CHIP R 47K J 1/16W	
R724			RK73HB1J823J	CHIP R 82K J 1/16W		R787,788			RK73HB1J472J	CHIP R 4.7K J 1/16W	
R725			RK73HB1J103J	CHIP R 10K J 1/16W		R789			RK73HB1J103J	CHIP R 10K J 1/16W	
R726			RK73HB1J100J	CHIP R 10 J 1/16W		R790			RK73HB1J102J	CHIP R 1.0K J 1/16W	
R728,729			RK73HB1J103J	CHIP R 10K J 1/16W		R793,794			R92-1368-05	CHIP R 0 OHM	
R730			RK73HB1J471J	CHIP R 470 J 1/16W		R796			R92-1368-05	CHIP R 0 OHM	
R731			RK73HB1J104J	CHIP R 100K J 1/16W		R797			RK73HB1J101J	CHIP R 100 J 1/16W	
R732			RK73HB1J182J	CHIP R 1.8K J 1/16W		R798			RK73HB1J332J	CHIP R 3.3K J 1/16W	
R733			RK73HB1J101J	CHIP R 100 J 1/16W		R799			RK73HB1J102J	CHIP R 1.0K J 1/16W	
R734			RK73HB1J121J	CHIP R 120 J 1/16W		R800			RK73HB1J104J	CHIP R 100K J 1/16W	
R735			RK73HB1J151J	CHIP R 150 J 1/16W		R801			RK73HB1J103J	CHIP R 10K J 1/16W	
R736			RK73HB1J121J	CHIP R 120 J 1/16W		R802			R92-1368-05	CHIP R 0 OHM	
R737			RK73HB1J151J	CHIP R 150 J 1/16W		R803			RK73HB1J154J	CHIP R 150K J 1/16W	
R738			RK73HB1J102J	CHIP R 1.0K J 1/16W		R804,805			RK73HB1J472J	CHIP R 4.7K J 1/16W	
R739			RK73HB1J104J	CHIP R 100K J 1/16W		R806			RK73HB1J154J	CHIP R 150K J 1/16W	
R740			RK73GB1J473J	CHIP R 47K J 1/16W		R807			RK73HB1J273J	CHIP R 27K J 1/16W	
R741			RK73HB1J104J	CHIP R 100K J 1/16W		R808			RK73GB1J155J	CHIP R 1.5M J 1/16W	
R742			RK73HB1J472J	CHIP R 4.7K J 1/16W		R809			RK73HB1J222J	CHIP R 2.2K J 1/16W	
R743			R92-1368-05	CHIP R 0 OHM		R810			RK73HB1J681J	CHIP R 680 J 1/16W	
R744			RK73HB1J102J	CHIP R 1.0K J 1/16W		R811			RK73HB1J470J	CHIP R 47 J 1/16W	
R745			R92-1368-05	CHIP R 0 OHM		R812			RK73HB1J222J	CHIP R 2.2K J 1/16W	
R746			RK73HB1J152J	CHIP R 1.5K J 1/16W		R813			RK73HB1J104J	CHIP R 100K J 1/16W	
R747			RK73HB1J564J	CHIP R 560K J 1/16W		R814,815			RK73HB1J472J	CHIP R 4.7K J 1/16W	
R749			RK73HB1J103J	CHIP R 10K J 1/16W		R816,817			RK73HB1J103J	CHIP R 10K J 1/16W	
R750			RK73HB1J103J	CHIP R 10K J 1/16W		R818			RK73HB1J101J	CHIP R 100 J 1/16W	
R751			RK73HB1J103J	CHIP R 10K J 1/16W		R819			RK73HB1J102J	CHIP R 1.0K J 1/16W	
R752			RK73HB1J223J	CHIP R 22K J 1/16W		R820			RK73HB1J123J	CHIP R 12K J 1/16W	
R753			R92-1252-05	CHIP R 0 OHM		R821			RK73HB1J101J	CHIP R 100 J 1/16W	
R754			RK73HB1J182J	CHIP R 1.8K J 1/16W		R824			RK73HB1J472J	CHIP R 4.7K J 1/16W	
R755,756			RK73HB1J102J	CHIP R 1.0K J 1/16W		R825			RK73HB1J223J	CHIP R 22K J 1/16W	
R757			RK73HB1J102J	CHIP R 1.0K J 1/16W		R826			RK73HB1J104J	CHIP R 100K J 1/16W	
R758			RK73GB1J221J	CHIP R 220 J 1/16W		R827,828			RK73HB1J823J	CHIP R 82K J 1/16W	
R759			RK73HB1J101J	CHIP R 100 J 1/16W		R829			RK73HB1J104J	CHIP R 100K J 1/16W	
R760			RK73GB1J560J	CHIP R 56 J 1/16W		R830			RK73HB1J102J	CHIP R 1.0K J 1/16W	
R761			RK73HB1J100J	CHIP R 10 J 1/16W		R831			RK73HB1J103J	CHIP R 10K J 1/16W	
R763			RK73HB1J563J	CHIP R 56K J 1/16W		R832,833			R92-1368-05	CHIP R 0 OHM	
R764			RK73HB1J184J	CHIP R 180K J 1/16W		R834			RK73HB1J473J	CHIP R 47K J 1/16W	
R765			RK73HB1J821J	CHIP R 820 J 1/16W		R835			RK73HB1J100J	CHIP R 10 J 1/16W	
R766			RK73HB1J222J	CHIP R 2.2K J 1/16W		R837			RK73HB1J104J	CHIP R 100K J 1/16W	
R767			RK73HB1J105J	CHIP R 1.0M J 1/16W		R839,840			RK73HB1J104J	CHIP R 100K J 1/16W	
R768			RK73HB1J332J	CHIP R 3.3K J 1/16W		R841			RK73HB1J273J	CHIP R 27K J 1/16W	
R769			RK73HB1J224J	CHIP R 220K J 1/16W		R842			RK73HB1J472J	CHIP R 4.7K J 1/16W	
R770			RK73HB1J221J	CHIP R 220 J 1/16W		R843			RK73HB1J104J	CHIP R 100K J 1/16W	
R771			RK73HB1J471J	CHIP R 470 J 1/16W		R844,845			RK73HB1J392J	CHIP R 3.9K J 1/16W	
R772			RK73HB1J561J	CHIP R 560 J 1/16W		R846			RK73HB1J272J	CHIP R 2.7K J 1/16W	
R773			RK73HB1J473J	CHIP R 47K J 1/16W		R848			RK73HB1J824J	CHIP R 820K J 1/16W	
R774			RK73HB1J102J	CHIP R 1.0K J 1/16W		R849			R92-1368-05	CHIP R 0 OHM	
R775			RK73HB1J474J	CHIP R 470K J 1/16W		R852			R92-1368-05	CHIP R 0 OHM	
R776			RK73HB1J102J	CHIP R 1.0K J 1/16W		R853			RK73HB1J224J	CHIP R 220K J 1/16W	
R777			RK73HB1J334J	CHIP R 330K J 1/16W		R854			RK73HB1J104J	CHIP R 100K J 1/16W	
R778			R92-1368-05	CHIP R 0 OHM		R855			RK73HB1J334J	CHIP R 330K J 1/16W	
R779,780			RK73HB1J153J	CHIP R 15K J 1/16W		R856			RK73HB1J104J	CHIP R 100K J 1/16W	
R781			RK73HB1J334J	CHIP R 330K J 1/16W		R857			RK73HB1J334J	CHIP R 330K J 1/16W	
R782			RK73HB1J104J	CHIP R 100K J 1/16W		R858,859			RK73HB1J152J	CHIP R 1.5K J 1/16W	

TH-F6A/F7E

PARTS LIST

TX-RX UNIT (X57-6360-00)

Ref. No.	Address	New parts	Parts No.	Description	Destination	Ref. No.	Address	New parts	Parts No.	Description	Destination
R860,861			RK73HB1J103J	CHIP R 10K J 1/16W		D58			1SS388	DIODE	
R862			RK73HB1J184J	CHIP R 180K J 1/16W		D59			RB717F	DIODE	
R863			RK73HB1J103J	CHIP R 10K J 1/16W				*	KV1566J	VARIABLE CAPACITANCE DIODE	
R864			RK73HB1J333J	CHIP R 33K J 1/16W		D60			HVU131	DIODE	
R865			R92-1368-05	CHIP R 0 OHM		D62			1SS385	DIODE	
						D63			HSC277	DIODE	
R866			R92-1252-05	CHIP R 0 OHM		D65			HSC277	DIODE	
R867			RK73HB1J102J	CHIP R 1.0K J 1/16W		D67,68			HSC277	DIODE	
R868			RK73HB1J820J	CHIP R 82 J 1/16W		D69			RB717F	DIODE	
R869			RK73HB1J823J	CHIP R 82K J 1/16W		D70			HVU131	DIODE	
R870			RK73HB1J822J	CHIP R 8.2K J 1/16W							
						D71			HSC277	DIODE	
R871			RK73HB1J474J	CHIP R 470K J 1/16W		D72		*	KV1811K	VARIABLE CAPACITANCE DIODE	
R872			RK73HB1J472J	CHIP R 4.7K J 1/16W		D73			HVU131	DIODE	
R875			R92-1368-05	CHIP R 0 OHM		D74			HSC277	DIODE	
R876			RK73HB1J223J	CHIP R 22K J 1/16W		D75-77		*	KV1811K	VARIABLE CAPACITANCE DIODE	
R877			R92-1368-05	CHIP R 0 OHM							
						D78			HSC277	DIODE	
R878			RK73HB1J101J	CHIP R 100 J 1/16W		D80			HSC277	DIODE	
R879			RK73HB1J104J	CHIP R 100K J 1/16W		D81		*	KV1811K	VARIABLE CAPACITANCE DIODE	
R880			RK73HB1J101J	CHIP R 100 J 1/16W		D82		*	MA2S111	DIODE	
VR701			R12-7494-05	TRIMMING POT.(220K)		D83		*	KV1811K	VARIABLE CAPACITANCE DIODE	
						D85			XB15A709	DIODE	K
S701-703		*	S70-0483-05	TACT SWITCH		D87-90		*	KV1811K	VARIABLE CAPACITANCE DIODE	
S704			S70-0477-05	TACT SWITCH		D91			HSC277	DIODE	
						D93,94			HSC277	DIODE	
MIC701			T91-0580-05	MIC ELEMENT		D95-97		*	KV1811K	VARIABLE CAPACITANCE DIODE	
D1		*	HZU2ALL	ZENER DIODE		D99-103			HSC277	DIODE	
D2			RB051L-40	DIODE		D104			MA2S111	DIODE	
D4		*	HZU2ALL	ZENER DIODE		D106			HVC375B	VARIABLE CAPACITANCE DIODE	
D5			1SS361	DIODE		D107-110			HVC131	DIODE	
D6			RB051L-40	DIODE		D112,113			HVC131	DIODE	
						D114			HVU131	DIODE	
D7			DA221	DIODE		D115,116			HSC277	DIODE	
D8,9			MA2S111	DIODE		D117,118			MA2S111	DIODE	
D10-12			HVC375B	VARIABLE CAPACITANCE DIODE		D119,120			HVC131	DIODE	K
D16			HVC375B	VARIABLE CAPACITANCE DIODE		D121			MA2S111	DIODE	
D18			HVC131	DIODE							
						D122			02DZ15(X,Y)	ZENER DIODE	
D20		*	KV1566J	VARIABLE CAPACITANCE DIODE		D123			MAZS0360H	ZENER DIODE	
D21			HVC131	DIODE		D124,125			HSC277	DIODE	
D24		*	KV1566J	VARIABLE CAPACITANCE DIODE		D126			02DZ15(X,Y)	ZENER DIODE	
D25			DAN235E	DIODE		D702-704			MA2S111	DIODE	K
D28			HVC375B	VARIABLE CAPACITANCE DIODE							
						D702			MA2S111	DIODE	T,E
D29		*	HVC376B	VARIABLE CAPACITANCE DIODE		D704			MA2S111	DIODE	T,E
D32		*	HVU187	DIODE		D705			RB706F-40	DIODE	
D33			MA2S111	DIODE		D706			MA2S111	DIODE	
D34			MA2S304	VARIABLE CAPACITANCE DIODE		D707,708			DA227	DIODE	
D35		*	1SV305	VARIABLE CAPACITANCE DIODE							
						D709			RB706F-40	DIODE	
D36			MA2S304	VARIABLE CAPACITANCE DIODE		D710,711			DA221	DIODE	
D37		*	1SV305	VARIABLE CAPACITANCE DIODE		D718			DAN222	DIODE	
D38			MA2S111	DIODE		D719			MA2S111	DIODE	
D40			HVC131	DIODE		D726		*	MAZS0360H	ZENER DIODE	
D41			1SS360	DIODE							
						D727			1SS388	DIODE	
D44			MA2S728	DIODE		D730,731			1SS388	DIODE	
D45			015AZ3.9	ZENER DIODE		D732			MA2S111	DIODE	
D49			HVC131	DIODE							
D51			HVC131	DIODE		IC1		*	LM3420-8.4	MOS IC	
D52			XB15A709	DIODE		IC2		*	LMX2326TMX	MOS IC	
						IC3			UPB1509GV	BI-POLAR IC	
D53			HVU131	DIODE		IC4			TA4101F	IC	
D54			HVC131	DIODE							
D57			HSC277	DIODE							

PARTS LIST

TX-RX UNIT (X57-6360-00)

Ref. No.	Address	New parts	Parts No.	Description	Destination	Ref. No.	Address	New parts	Parts No.	Description	Destination
IC5		*	TK10931V	ANALOG IC		Q47			DTA114YE	DIGITAL TRANSISTOR	
IC6		*	LMX2326TMX	MOS IC		Q48			2SK1824	FET	
IC7			TA31136FN	MOS IC		Q49			2SK1830	FET	
IC8,9			LMC7101BIM5	MOS IC		Q50			2SC4617(R)	TRANSISTOR	
IC10		*	UPC2746TB	BI-POLAR IC		Q51			2SK1830	FET	
IC11			BU2099FV	MOS IC		Q52			2SK1824	FET	
IC701			TA75W558FU	MOS IC		Q53		*	UMA6N	TRANSISTOR	
IC702			NJM2107F	MOS IC		Q54		*	2SK2973	FET	
IC703			TC7S66FU	MOS IC		Q55			2SK3476	FET	
IC704			AT25128N10SI27	ROM IC		Q56		*	2SK2973	FET	
IC705		*	78F4216AJYUBK	MPU	K	Q57			2SK3476	FET	K
IC705		*	78F4216AJYVBK	MPU	T,E	Q58			2SC4617(R)	TRANSISTOR	
IC706			M62364FP	MOS IC		Q59			3SK320	FET	
IC707			TA7368F	MOS IC		Q62-64			3SK320	FET	
IC708		*	XC6202P402PR	MOS IC		Q65			2SK3019	FET	
IC709			PST9130NR	MOS IC		Q66			2SJ243	FET	
IC710			RN5VL35A	MOS IC		Q68		*	RN47A5	TRANSISTOR	
IC711			TA75W01FU	MOS IC		Q69			DTC144EE	DIGITAL TRANSISTOR	
IC712			TC4W53FU	MOS IC		Q70			2SJ243	FET	
IC713		*	LM2681	MOS IC		Q71			2SC4226(R24)	TRANSISTOR	
IC714			TA75W01FU	MOS IC		Q72			2SC5192	TRANSISTOR	
IC715		*	TK11930M	MOS IC		Q73			2SC4617(R)	TRANSISTOR	
IC717			TC75S51F	MOS IC		Q74			2SK1824	FET	
IC718			LMC7101BIM5	MOS IC		Q76		*	2SC4725	TRANSISTOR	
IC719,720			NJM2107F	MOS IC		Q92			DTA143ZE	DIGITAL TRANSISTOR	
Q1			2SD1760	TRANSISTOR		Q93		*	MT6C03AE	TRANSISTOR	
Q2			DTC123JE	DIGITAL TRANSISTOR		Q94			DTC144EE	DIGITAL TRANSISTOR	
Q3			DTA143ZE	DIGITAL TRANSISTOR		Q95,96			2SK1830	FET	
Q4			HN1K02FU	FET		Q97			2SC5009	TRANSISTOR	
Q5			2SK1830	FET		Q98			2SK1830	FET	
Q6			2SK1824	FET		Q99			UMA6N	TRANSISTOR	K
Q7			2SC4617(S)	TRANSISTOR		Q100			2SJ347	FET	
Q8			2SK1830	FET		Q701			2SC4617(R)	TRANSISTOR	
Q9		*	MT6C03AE	TRANSISTOR		Q702			2SJ347	FET	
Q10			UPA573T	FET		Q703			2SC4081	TRANSISTOR	
Q11-13			2SC5009	TRANSISTOR		Q704			2SJ347	FET	
Q14			SSM3J05FU	FET		Q705			2SK1830	FET	
Q15			UPA573T	FET		Q706			2SK1588	FET	
Q17			2SJ243	FET		Q707			2SJ347	FET	
Q19			2SC5108(Y)	TRANSISTOR		Q708			2SK1830	FET	
Q21			2SC5009	TRANSISTOR		Q709			2SC4617(R)	TRANSISTOR	
Q22			UPA672T	FET		Q710			2SB1184(Q,R)	TRANSISTOR	
Q23			UMX2N	TRANSISTOR		Q712			DTB113ZK	DIGITAL TRANSISTOR	
Q24		*	2SC4915	TRANSISTOR		Q713			UMA10N	TRANSISTOR	
Q25			2SC4617(R)	TRANSISTOR		Q714		*	RN47A5	TRANSISTOR	
Q26,27		*	2SC4915	TRANSISTOR		Q715			UMA10N	TRANSISTOR	
Q28		*	MT6C03AE	TRANSISTOR		Q716			DTA143ZE	DIGITAL TRANSISTOR	
Q29			UPA672T	FET		Q719,720			2SC4617(R)	TRANSISTOR	
Q30			2SJ347	FET		Q721			2SJ347	FET	
Q31			2SC4617(S)	TRANSISTOR		Q722			2SK1830	FET	
Q32			2SK1830	FET		Q723			DTC114EE	DIGITAL TRANSISTOR	
Q34		*	MT6C03AE	TRANSISTOR		Q725			2SB1184(Q,R)	TRANSISTOR	
Q35		*	HN1J02FU	FET		Q726			2SC4919	TRANSISTOR	
Q37			2SC5108(Y)	TRANSISTOR		Q727		*	RN47A5	TRANSISTOR	
Q40,41			2SC5009	TRANSISTOR		Q728			UMX2N	TRANSISTOR	
Q43			2SC5108(Y)	TRANSISTOR		Q729			2SK1830	FET	
Q44		*	2SC4915	TRANSISTOR		TH1		*	ERTJ0EV104H	THERMISTOR	
Q45		*	MT6C04AE	TRANSISTOR		TH2			157-471-65001	THERMISTOR	
Q46			3SK320	FET		TH701			157-503-65001	THERMISTOR	

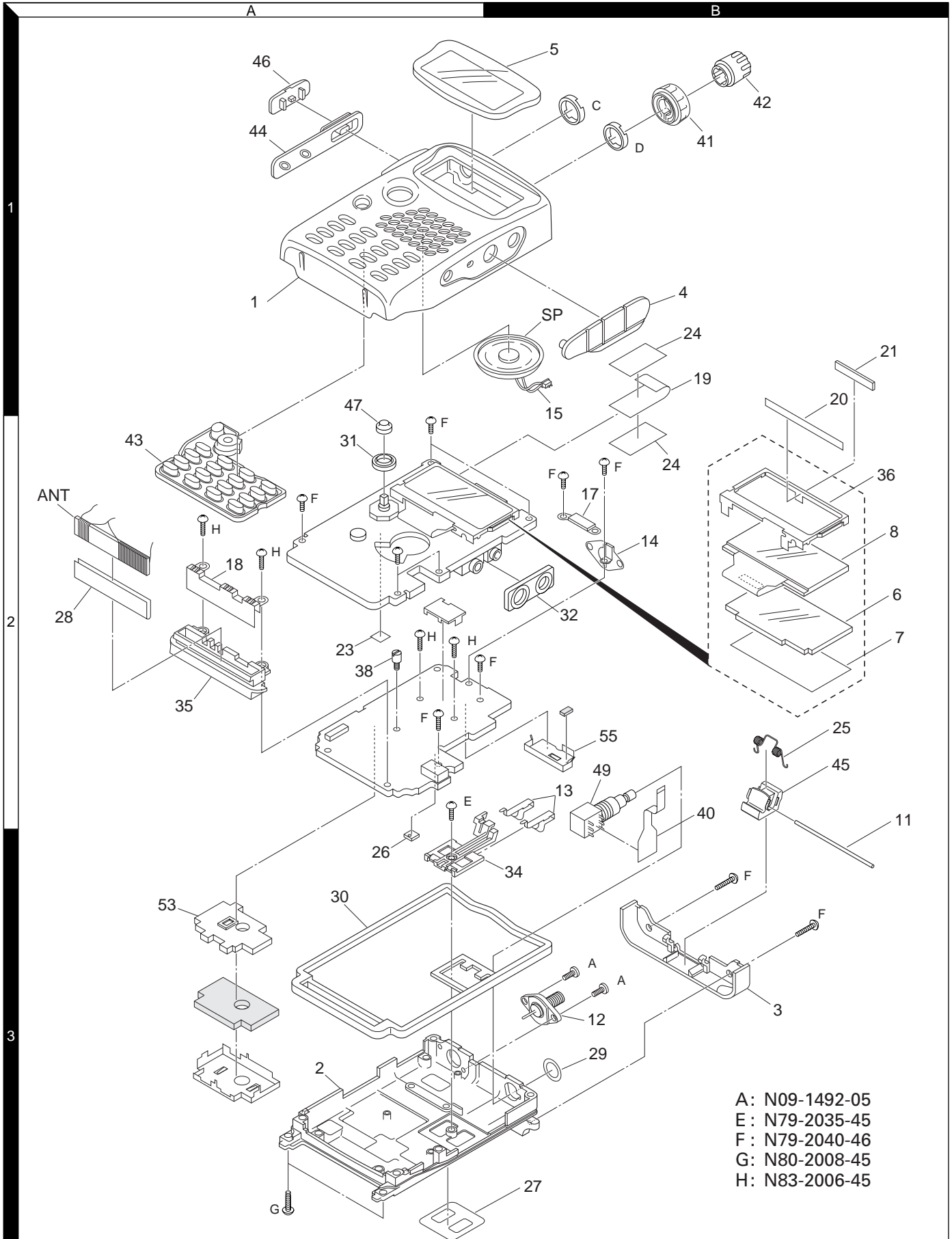

- A: N09-1492-05
- E: N79-2035-45
- F: N79-2040-46
- G: N80-2008-45
- H: N83-2006-45

PACKING

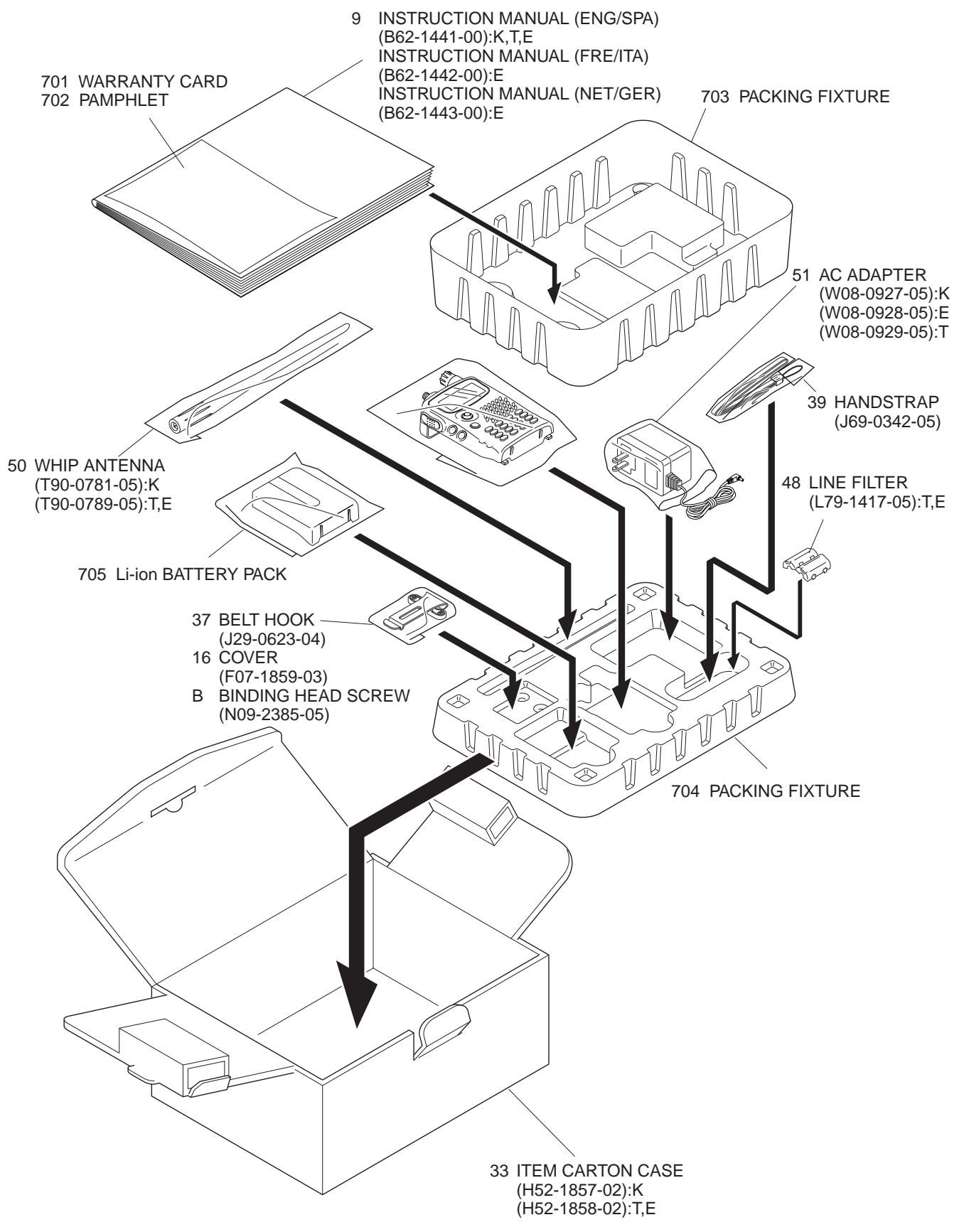

ADJUSTMENT

REQUIRED TEST EQUIPMENT

1. Stabilized Power Supply

- ① The supply voltage can be changed between 3V and 16V and the current is 1A or more.
- ② The standard voltage is 13.8V.

2. DC Ammeter (DC.A)

- ① Class 1 ammeter (17 ranges and other features)
- ② The full scale can be switched between 300mA and 3A.
- ③ A cable with low internal loss must be used.

3. Frequency Counter (f. counter)

- ① Frequencies of up to 1 GHz or so can be measured.
- ② The sensitivity can be changed to 250 MHz or below and measurements are highly stable and accurate (about 0.2 ppm).

4. Power Meter (terminal type)

- ① Measurable frequency: Up to 500 MHz
- ② Impedance: 50Ω, unbalanced
- ③ Measuring range: Full scale of 10W
- ④ The specified special connection cable must be used.

5. RF VTVM (RF V.M)

- ① Measurable frequency: Up to 500 MHz or so

6. Linear Detector

- ① Measurable frequency: Up to 500 MHz
- ② Characteristic is flat and CN is 60 dB or more.

7. Digital Voltmeter

- ① Voltage range: FS = 18V or so
- ② Input resistance: 1MΩ or more

8. Oscilloscope

- ① Measuring range: DC to 30 MHz
- ② Provides highly accurate measurements for 5 to 25 MHz

9. AF Voltmeter (AF V.M)

- ① Measurable frequency: 50 Hz to 1 MHz
- ② Maximum sensitivity: 1mV or more

10. Spectrum Analyzer

- ① Measuring range: DC to 1GHz or more

11. Standard Signal Generator (SSG)

- ① Maximum frequency: 500MHz or more
- ② Output: -133 dBm (0.05 μV) to -13 dBm (50mV)
- ③ Output impedance: 50Ω

12. Tracking Generator

- ① Center frequency: 50 kHz to 200 MHz
- ② Frequency deviation: ±35 MHz
- ③ Output voltage: 100 mV or more

13. Dummy Load

- ① 8Ω, 3W or more

Adjustment service jig

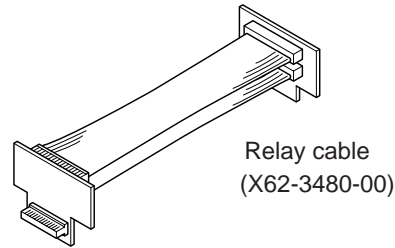

Relay cable
(X62-3480-00)

Used to connect the control unit with the RF unit.

Adjustment Points

TX-RX unit

Control section

(Component Side View)

(Foil Side View)

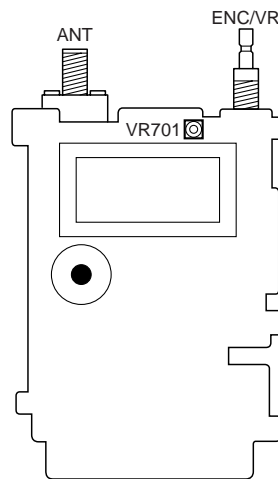

VR701: LCD contrast

LCD: VLCD voltage point

TX-RX unit

(Foil Side View)

(Component Side View)

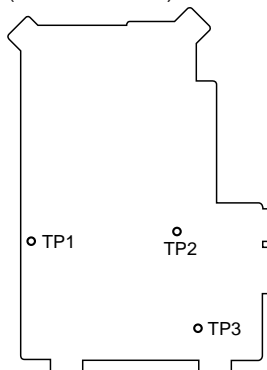

TP1: A -Band Lock Voltage Point.
TP2: B -Band Lock Voltage Point.
TP3: 2nd Local frequency

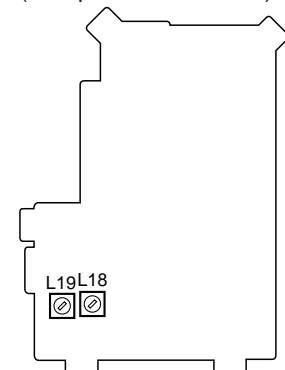

L18: RX Demodulation
(W-FM)
L19: RX Demodulation
(FM)

ADJUSTMENT

Single tone transmission

Function Overview

- This function enables you to transmit a single tone.

Example

- It is used to adjust DTMF deviation during production.

Operation

- ① Press [PTT] and enter transmission mode.
- ② Press [MONI] to enter the single tone mode.
- ③ Press any of [1] to [8] numeric keys to transmit a single tone.

Details

- The single tone has eight frequencies.

[1]	697Hz
[2]	770Hz
[3]	852Hz
[4]	941Hz
[5]	1209Hz
[6]	1336Hz
[7]	1477Hz
[8]	1633Hz

- The single tone mode can be enabled only during transmission.
- When the unit returns from transmission mode to reception mode, the single tone mode is canceled. When transmission mode is set again and a numeric key is pressed, dual tone (DTMF) is transmitted.
- When [MONI] is pressed again in single tone mode, it returns to dual to tone mode.
- A dual tone is transmitted during DTMF memory transmission even in the single tone mode.

Service Setup Mode

Function Overview

A. Power supply voltage	:Set power supply voltage to 6.5 V.
B. TCXO	:PLL reference TCXO adjustment
C. BPF	:Adjust the BPF tune level.
D. 2nd local	:Adjust the B band 2nd local oscillator.
E. SSB BFO	:Adjust the SSB offset frequency (LSB, USB) level.
F. Squelch	:Adjust the squelch threshold and level 2 (level 2) voltage.
G. S meter	:Adjust the first segment and all-segment ON level of the S meter.
H. APC	:Adjust the HI, LOW, EL transmission power.
I. DCS modulation balance	:Adjust the DCS modulation balance.
J. MAX deviation	:Adjust the max deviation.
K. Tone deviation	:Adjust the tone deviation.
L. DCS deviation	:Adjust the DCS deviation.
M. 9600 deviation	:Adjust the 9600 deviation.
N. VOX gain adjustment	:Adjust VOX gain.

Example

- It is used to replace the EEPROM, readjust it, or review the design in a service center.

Operation

- 1) Set the tone frequency and DCS code of each of the frequency bands (144, 200, 400, 1200) of the A band to specified values.
- 2) Set single band mode.
- 3) Service Setup Mode appears when accessing two illustrated lands on the component mounted side of the TX-RX Unit (A/3) while the transceiver is switched ON. When the Service Setup Mode is set, the following is displayed and adjustment item setting state is displayed on the non-operation band side.

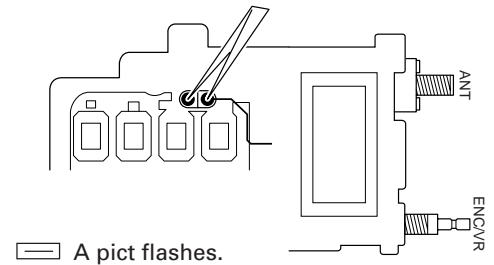

```
▶144.000
| VOLT : 83 : FF |
```

- [◀], [▶] : Changes adjustment items.
- [▲], [▼] : Increase or decrease frequency and memory channel number.
- Encoder : Increase or decrease the adjustment value (real-time value).
- [MNU] : Set the adjusted real-time value in the EEPROM.
- Press [LAMP] : Press the [LAMP] key to enter into the menu modes. To release the mode, press the key once again.
- Keys other than the above can be operated normally.

A. Power supply voltage adjustment

- 1) Display the "VOLT" item.
- 2) Set power supply voltage to 6.5 V.
- 3) Press [MNU] key to set the 6.5V reference voltage in the EEPROM.

Overvoltage warning, battery remaining voltage display and APC are controlled based on this value.

```
▶144.000
| VOLT : 83 : FF |
      ↑       ↑
Real-time value EEPROM setting
```

B. TCXO adjustment

- 1) Display the "TCXO" item.
- 2) The "real-time value" can be changed by turning the encoder during transmission with "L" power.
- 3) Press [MNU] key to set the "real-time value" in the EEPROM.

```
▶144.000
| TCXO : 83 : FF |
      ↑       ↑
Real-time value EEPROM setting
```

ADJUSTMENT

C. BPF adjustment

- 1) Display the "BPF" item.
- 2) Select points f1 to f3 as shown in the "Frequency Adjustment Points" table below.
- 3) Set the display frequency to the frequency appropriate to the frequency adjustment point.
- 4) Turn the encoder to change the "real-time value".
- 5) Press [MNU] key to set the "real-time value" in the EEPROM.
- 6) Adjust all frequency adjustment points.

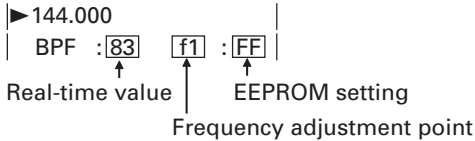

• Frequency adjustment points

Band		Frequency adjustment point
A band	144MHz	3 points (f1, f2, f3)
	220MHz	3 points (f1, f2, f3) K destination only
	Others	No adjustment
B band	AM radio	3 points (f1, f2, f3)
	HF	3 points (f1, f2, f3)
	50,FM radio	3 points (f1, f2, f3)
	118,144	3 points (f1, f2, f3)
	TV-V,200	3 points (f1, f2, f3)
	Others	No adjustment

- To adjust "AM radio" or "HF" band, the bar antenna must be activated (factory default: ON).
- If a band does not require adjustment, the following message appears. Operations 4) and 5) are invalid.



D. Second local adjustment

- 1) Display the [2nd: 0] item.
- 2) Set the operation band to B band.
- 3) Set display frequency to the adjustment frequency.
- 4) Turn the encoder, change the "real-time value", and maximize the receiver volume. (Max. sensitivity)
- 5) Press [MNU] key to set the "real-time value" in the EEPROM.
- 6) Display the [2nd: -25] item.
- 7) Set the measuring equipment frequency to the "display frequency -2.5kHz" and perform steps 4) and 5).
- 8) Display the [2nd: +25] item.
- 9) Set the measuring equipment frequency to the "display frequency +2.5kHz" and perform steps 4) and 5).

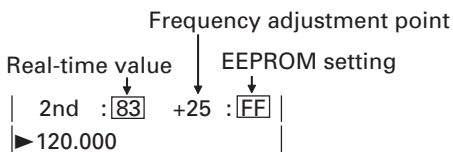

- Adjustment in FINE mode.
- Adjustment in B band only.
- There are only three frequency adjustment points (0, -25 and +25).

- If the operation band is A band, no adjustment is required, and the following message appears. Operations 4) and 5) are invalid.



E. SSB BFO adjustment

Note: You do not need to adjust [BFO: SW].

- 1) Display the [BFO: LS] item.
- 2) Set demodulation mode to LSB.
- 3) Turn the encoder, change the "real-time value", and set the detection frequency to 1 kHz.
- 4) Press [MNU] key to set the "real-time value" in the EEPROM.
- 5) Display the [BFO: US] item.
- 6) Set demodulation mode to USB.
- 7) Turn the encoder, change the "real-time value", and set the detection frequency to 1 kHz.
- 8) Press [MNU] key to set the "real-time value" in the EEPROM.

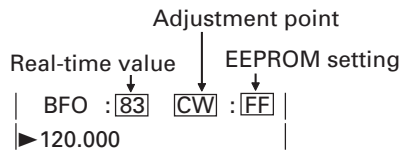

- Adjustment in B band only
- There are only two adjustment points (LS and US).
- If the operation band is A band, no adjustment is required and the following message appears. Operations 3), 4), 7) and 8) are invalid.



F. Squelch adjustment

- 1) Display the [SQ: 1] item.
- 2) Set the display frequency and demodulation mode as shown in the "Frequency/Mode Adjustment Points" table below.
- 3) Press [MNU] key to set the "real-time value" in the EEPROM as a threshold value.
- 4) Display the [SQ: 2] item.
- 5) Press [MNU] key to set the "real-time value" in the EEPROM as a level 2 value.
- 6) Adjust all frequency/mode adjustment points.

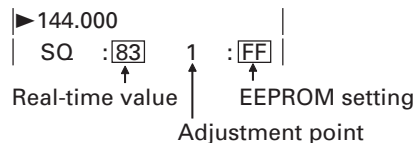

ADJUSTMENT

- Frequency/mode adjustment points

Band	Mode	Adjustment point	
A band	144MHz	FM	2 points (Threshold, level 2)
	220MHz	FM	2 points (Threshold, level 2) K destination only
	400MHz	FM	2 points (Threshold, level 2)
B band	AM radio	FM	2 points (Threshold, level 2)
	HF	FM	2 points (Threshold, level 2)
	50MHz	FM	2 points (Threshold, level 2)
	80MHz	W-FM	2 points (Threshold, level 2)
	120MHz	FM	2 points (Threshold, level 2)
	144MHz	FM	2 points (Threshold, level 2)
	TV-V	W-FM	2 points (Threshold, level 2)
	200MHz	FM	2 points (Threshold, level 2)
	400MHz	FM	2 points (Threshold, level 2)
	TV-U	W-FM	2 points (Threshold, level 2)
	1200MHz	FM	2 points (Threshold, level 2)

- To adjust "AM radio" or "HF" band, the bar antenna must be activated (factory default: ON).

G. S meter adjustment

- Display the [SM: S1] item.
- Set the display frequency and demodulation mode as shown in the "Frequency/Mode Adjustment Points" table below.
- Press [MNU] key to set the "real-time value" in the EEPROM as the first segment ON value.
- Display the [SM: S9] item.
- Press [MNU] key to set the "real-time value" in the EEPROM as all-segment ON value.
- Adjust all frequency/mode adjustment points.

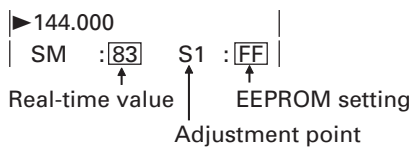

- Frequency/mode adjustment points

Band	Mode	Adjustment point	
A band	144MHz	FM	2 points (First segment ON, all-segment ON)
	220MHz	FM	2 points (First segment ON, all-segment ON) K destination only
	400MHz	FM	2 points (First segment ON, all-segment ON)
B band	AM radio	FM	2 points (First segment ON, all-segment ON)
	HF	FM	2 points (First segment ON, all-segment ON)
	50MHz	FM	2 points (First segment ON, all-segment ON)
	80MHz	W-FM	2 points (First segment ON, all-segment ON)
	120MHz	FM	2 points (First segment ON, all-segment ON)
	144MHz	FM	2 points (First segment ON, all-segment ON)
	TV-V	W-FM	2 points (First segment ON, all-segment ON)
	200MHz	FM	2 points (First segment ON, all-segment ON)
	400MHz	FM	2 points (First segment ON, all-segment ON)
	TV-U	W-FM	2 points (First segment ON, all-segment ON)
	1200MHz	FM	2 points (First segment ON, all-segment ON)

- To adjust "AM radio" or "HF" band, the bar antenna must be activated (factory default: ON).

H. APC adjustment

- Display the [P: BAf1] item.
 - Set the A band to the operation band.
 - Set power supply voltage to 6 V.
 - Set display frequency and transmission power as shown in the "Frequency/Power Adjustment Points" table below.
 - Press [PTT] and turn the encoder during transmission to increase or decrease transmission power and change the "real-time value".
 - Press [MNU] key to set the "real-time value" in the EEPROM.
 - Set the item display to "f2" and "f3" and adjust all frequency/power adjustment points.
 - Display the [P: 7f1] item.
 - Set the power supply voltage to 7.4 V and perform steps 4 to 7 above.
 - Display the [P: 13f1] item.
 - Set the power supply voltage to 13.8 V.
 - Set transmission power to H and perform steps 4) to 7).
- For any band that does not requires three-point adjustment, enter the same data at all three points.

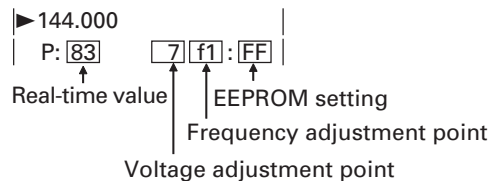

- Frequency/power/power supply voltage adjustment points

Power supply voltage	Band	Power	Frequency adjustment point	
Dry cell 6[v]	144MHz	H	3 points (f1, f2, f3)	
		L	3 points (f1, f2, f3)	
		EL	3 points (f1, f2, f3)	
	220MHz	H	3 points (f1, f2, f3) K destination only	
		L	3 points (f1, f2, f3) K destination only	
		EL	3 points (f1, f2, f3) K destination only	
		400MHz	H	3 points (f1, f2, f3)
			L	3 points (f1, f2, f3)
			EL	3 points (f1, f2, f3)
Lithium ion 7.4[v]	144MHz	H	3 points (f1, f2, f3)	
		L	3 points (f1, f2, f3)	
		EL	3 points (f1, f2, f3)	
	220MHz	H	3 points (f1, f2, f3) K destination only	
		L	3 points (f1, f2, f3) K destination only	
		EL	3 points (f1, f2, f3) K destination only	
		400MHz	H	3 points (f1, f2, f3)
			L	3 points (f1, f2, f3)
			EL	3 points (f1, f2, f3)
13.8[v]	144MHz	H	3 points (f1, f2, f3)	
		L	3 points (f1, f2, f3)	
		EL	3 points (f1, f2, f3)	

ADJUSTMENT

Power supply voltage	Band	Power	Frequency adjustment point
13.8[V]	220MHz	H	3 points (f1, f2, f3) K destination only
		L	3 points (f1, f2, f3) K destination only
		EL	3 points (f1, f2, f3) K destination only
	400MHz	H	3 points (f1, f2, f3)
		L	3 points (f1, f2, f3)
		EL	3 points (f1, f2, f3)

- If no adjustment is necessary for an item (for example, 50 MHz f2), the following message appears. Operations 5) and 6) are invalid.

```
| P : **   f2 : ** |
| ▶50.000 |
```

I. DCS balance adjustment

- Display the "BAL" item.
- Set the A band to the operation band.
- Select points f1 to f3 as shown in the "Frequency Adjustment Points" table below.
- Set the display frequency to the frequency appropriate to the frequency adjustment point.
- Press [PTT] and turn the encoder during transmission to change the "real-time value".
- Press [MNU] key to set the "real-time value" in the EEPROM.
- Adjust all frequency adjustment points.

```
▶ 144.000
| BAL : 83  f1 : FF |
|           ↑   ↑   |
| Real-time value Frequency adjustment point
|           ↑   ↑   |
|           EEPROM setting
```

- Frequency adjustment points

Band	Frequency adjustment point
144MHz	3 points (f1, f2, f3)
220MHz	3 points (f1, f2, f3) K destination only
400MHz	3 points (f1, f2, f3)

- When transmission is performed in DCS balance adjustment mode, a 100Hz square waveform is modulated.
- If no adjustment is necessary for an item (for example, 50 MHz f2), the following message appears. Operations 5) and 6) are invalid.

```
| BAL : **   f2 : ** |
| ▶50.000 |
```

J. Max deviation adjustment

- Display the "MAX" item.
- Set the A band to the operation band.
- Select points f1 to f3 as shown in the "Frequency Adjustment Points" table below.
- Set the display frequency to the frequency appropriate to the frequency adjustment point.
- Press [PTT] and turn the encoder during transmission to change the "real-time value".

- Press [MNU] key to set the "real-time value" in the EEPROM.

- Adjust all frequency adjustment points.

```
▶ 144.000
| MAX : 83  f1 : FF |
|           ↑   ↑   |
| Real-time value Frequency adjustment point
|           ↑   ↑   |
|           EEPROM setting
```

- Frequency adjustment points

Band	Frequency adjustment point
144MHz	3 points (f1, f2, f3)
220MHz	3 points (f1, f2, f3) K destination only
400MHz	3 points (f1, f2, f3)

- If no adjustment is necessary for an item (for example, 50 MHz f2), the following message appears. Operations 5) and 6) are invalid.

```
| MAX : **   f2 : ** |
| ▶50.000 |
```

K. Tone deviation adjustment

- Display the "TON" item.
- Set the A band as the operation band.
- Select points f1 to f3 as shown in the "Frequency Adjustment Points" table below.
- Set the display frequency to the frequency appropriate to the frequency adjustment point.
- Press [PTT] and turn the encoder during transmission to change the "real-time value".
- Press [MNU] key to set the "real-time value" in the EEPROM.
- Adjust all frequency adjustment points.

```
▶ 144.000
| TON : 83  f1 : FF |
|           ↑   ↑   |
| Real-time value Frequency adjustment point
|           ↑   ↑   |
|           EEPROM setting
```

- Frequency adjustment points

Band	Frequency adjustment point
144MHz	3 points (f1, f2, f3)
220MHz	3 points (f1, f2, f3) K destination only
400MHz	3 points (f1, f2, f3)

- The tone frequency of each band must be set to a specified value before entering the service adjustment mode.
- To adjust, switch the tone ON (ensure to switch it OFF after adjustment).
- If no adjustment is necessary for an item (for example, 50 MHz f2), the following message appears. Operations 5) and 6) are invalid.

```
| TON : **   f2 : ** |
| ▶50.000 |
```

ADJUSTMENT

L. DCS deviation adjustment

- 1) Display the "DCS" item.
- 2) Set the A band as the operation band.
- 3) Select points f1 to f3 as shown in the "Frequency Adjustment Points" table below.
- 4) Set the display frequency to the frequency appropriate to the frequency adjustment point.
- 5) Press [PTT] and turn the encoder during transmission to change the "real-time value".
- 6) Press [MNU] key to set the "real-time value" in the EEPROM.
- 7) Adjust all frequency adjustment points.

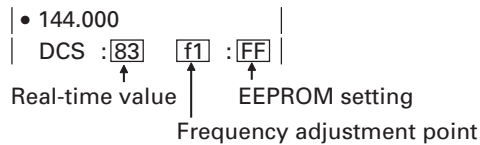

• Frequency adjustment points

Band	Frequency adjustment point
144MHz	3 points (f1, f2, f3)
220MHz	3 points (f1, f2, f3) K destination only
400MHz	3 points (f1, f2, f3)

- The DCS code of each band must be set to a specified value before entering the service adjustment mode.
- To adjust, switch the DCS ON (ensure to switch it OFF after adjustment).
- If no adjustment is necessary for an item (for example, 50 MHz f2), the following message appears. Operations 5) and 6) are invalid.



M. 9600 deviation adjustment

- 1) Display the "96" item.
- 2) Set the A band as the operation band.
- 3) Select points f1 to f3 as shown in the "Frequency Adjustment Points" table below.
- 4) Set the display frequency to the frequency appropriate to the frequency adjustment point.
- 5) Press [PTT] and turn the encoder during transmission to change the "real-time value".
- 6) Press [MNU] key to set the "real-time value" in the EEPROM.
- 7) Adjust all frequency adjustment points.

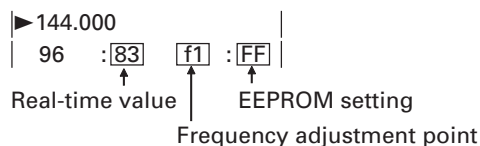

• Frequency adjustment points

Band	Frequency adjustment point
144MHz	3 points (f1, f2, f3)
220MHz	3 points (f1, f2, f3) K destination only
400MHz	3 points (f1, f2, f3)

- If no adjustment is necessary for an item (for example, 50 MHz f2), the following message appears. Operations 5) and 6) are invalid.

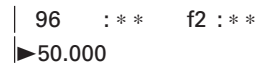

When this item is selected, set 9600 (menu) to ON. When this item is deselected, set it to OFF. Press [LAMP] key in the Service Setup mode to enter a menu mode.

N. VOX gain adjustment

- 1) Display the "VOX" item [1].
- 2) Enter the voltage of level 1 of the VOX gain.
- 3) Press [MNU] key to set the "real-time value" in the EEPROM.
- 4) Display the "VOX" item [9].
- 5) Enter the voltage of level 9 of the VOX gain.
- 6) Press [MNU] key to set the "real-time value" in the EEPROM.

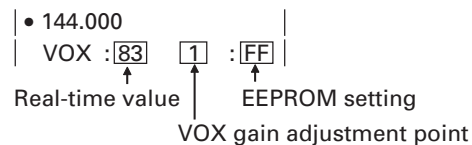

To adjust, switch VOX ON (ensure to switch it OFF after adjustment).

To terminate the Service Setup mode, turn the power supply OFF.



ADJUSTMENT

Common section

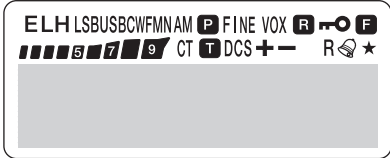
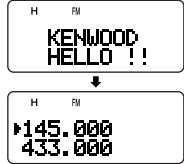
Item	Conditions	Measurement			Adjustment			Specifications/Remarks
		Test equipment	Unit	Terminal	Unit	Parts	Method	
1. Setting and resetting	1) External power supply connection DC IN terminal voltage: 13.8V 2) Total illumination display confirmation Turn the power switch on while pressing the F key 3) Full-resetting and install value setting Release [F] Select the reset mode by turning the tuning control or press[▲]/[▼]. If you select "NO", the transceiver exits the reset mode.	LCD total illumination display 			Internal value setting display after all resetting 			Example: E,T Type
2. LCD contrast	1) Ta=+25°C	Digital	TX-RX (A/3)	LCD	TX-RX (A/3)	VR701	Adjust to Max Vlotage	Max Voltage Level
3. VCO Lock voltage	A-Band	Digital Voltmeter	TX-RX (B/3)	TP1			Check	0.7V or more
	1) Frequency:137.00MHz							5.5V or less
	2) Frequency:173.99MHz							0.7V or more
	3) Frequency:216.00MHz (K-only)							5.5V or less
	4) Frequency:259.99MHz (K-only)							0.7V or more
	5) Frequency:410.00MHz							5.5V or less
	6) Frequency:469.99MHz							0.7V or more
	B-Band			TP2			Check	0.7V or more
	7) Frequency:23.00MHz							
	8) Frequency:42.39MHz							0.7V or more
	9) Frequency:142.40MHz							5.5V or less
	10) Frequency:182.39MHz							0.7V or more
	11) Frequency:182.40MHz							5.5V or less
	12) Frequency:222.39MHz							0.7V or more
	13) Frequency:502.40MHz							5.5V or less
	14) Frequency:591.99MHz							0.7V or more
Battery Voltage Align / Check	Switch to Service Setup mode and carry out the operations for item A	DC Power Supply		DC-IN		MNU	Write	
	1) Frequency:145.000MHz (E,T) Frequency:146.000MHz (K) DC-IN:6.5V							Check for alarm sound and messgae "VOLTAGE ERROR"
	2) Frequency:145.000MHz (E,T) Frequency:146.000MHz (K) DC-IN:17V							Press <F>,<LOW> Key to check for 1-segment display on the battery meter
	3) Frequency:145.000MHz (E,T) Frequency:146.000MHz (K) Battery Terminal:7.6V							1~2 bars

ADJUSTMENT

Receiver section

Item	Conditions	Measurement			Adjustment			Specifications/Remarks
		Test equipment	Unit	Terminal	Unit	Parts	Method	
1.2nd Local	Switch to Service Setup mode and carry out the operations for item D. 1) B-Band Frequency:146.050MHz (USB) 2) Frequency:-2.5KHz shift 3) Frequency:+2.5KHz shift	f.counter Spectrum analyzer	TX-RX B/3	TP3		Tuning control	Write	57.1500MHz ± 50Hz 57.1475MHz ± 50Hz 57.1525MHz ± 50Hz
2. RX Demodulation	1) B-Band Frequency:146.050MHz (FM) SSG:(0dBm) 224mV FM:3KHz	SSG Distortion Meter AF.V.M		ANT S.P		L19	Tune L19 to obtain min distortion and max AF OUTPUT.	Min. Distortion
	2) Frequency:90.100MHz(W-FM) SSG:(0dBm) 224mV FM:50KHz	Oscilloscope				L18	Tune L18 to obtain min distortion and max AF OUTPUT	Min. Distortion
RX BPF tune	Switch to Service Setup mode and carry out the operations for item C. A-Band 1) Frequency:145.050MHz SSG:(-53dBm) 501µV Mode:FM (3KHz) AF VR:0.63V/8Ω SSG:(-121dBm) 0.199µV 2) Frequency:137.000MHz SSG:(-115dBm) 0.398µV 3) Frequency:173.990MHz SSG:(-121dBm) 0.199µV 4) Frequency:223.550MHz (K-Type only) SSG:(-120dBm) 0.22µV 5) Frequency:216.000MHz (K-Type only) SSG:(-115dBm) 0.398µV 6) Frequency:259.990MHz (K-Type only) SSG:(-103dBm) 1.58µV B-Band 7) Frequency:146.100MHz SSG:(-117dBm) 0.32µV 8) Frequency:118.100MHz SSG:(-110dBm) 0.707µV 9) Frequency:173.900MHz SSG:(-120dBm) 0.22µV 10)Frequency:50.100MHz SSG:(-115dBm) 0.398µV 11)Frequency:90.100MHz SSG:(-93dBm) 5.01µV 12)Frequency:107.900MHz SSG:(-110dBm) 0.707µV	SSG Oscilloscope Distortion Meter AF.V.M	TX-RX	ANT SP		Tuning control	Write	Max. Sensitivity
	13)With no device is connected to the antenna terminal, put the transceiver in receive mode. Frequency:MW0.540MHz 14)Frequency:MW0.800MHz 15)Frequency:MW1.200MHz 16)Frequency:SW3.000MHz 17)Frequency:SW6.550MHz 18)Frequency:SW10.090MHz	Oscilloscope AF.V.M Distortion					Tuning control MNU key	Turn the Tuning control to obtain max AF output. Write

ADJUSTMENT

Item	Conditions	Measurement			Adjustment			Specifications/Remarks
		Test equipment	Unit	Terminal	Unit	Parts	Method	
SSB BFO Align	Switch to Service Setup mode and carry out the operations for item E. B-Band	SSG Oscilloscope Distortion Meter f. counter AF.V.M				Tuning control MNU key	Write	1KHz ± 50Hz
	1) USB Frequency:145.800MHz SSG:(-53dBm) 501μV Mode:OFF AF VOL:0.63V/8Ω							1KHz ± 50Hz
Squelch write	Switch to Service Setup mode and carry out the operations for item F. A-Band	SSG	TX-RX	ANT	TX-RX	MNU key	Write	
	1) Frequency:145.050MHz SQL1 SSG:(-127dBm) 0.1μV SQL2 SSG:(-124dBm) 0.141μV							
Squelch write	2) Frequency:435.050MHz(E,T) Frequency:440.000MHz(K) SQL1 SSG:(-125dBm) 0.126μV SQL2 SSG:(-120dBm) 0.22μV	SSG	TX-RX	ANT	TX-RX	MNU key	Write	
	3) Frequency:223.550MHz(K) SQL1 SSG:(-125dBm) 0.126μV SQL2 SSG:(-120dBm) 0.22μV							
Squelch write	B-Band	SSG	TX-RX	ANT	TX-RX	MNU key	Write	
	4) Frequency:14.100MHz (AM) SQL1 SSG:(-110dBm) 0.707μV SQL2 SSG:(-105dBm) 1.3μV							
Squelch write	5) Frequency:51.100MHz (FM) SQL1 SSG:(-120dBm) 0.22μV SQL2 SSG:(-115dBm) 0.398μV	SSG	TX-RX	ANT	TX-RX	MNU key	Write	
	6) Frequency:120.100MHz (AM) SQL1 SSG:(-110dBm) 0.707μV SQL2 SSG:(-105dBm) 1.3μV							
Squelch write	7) Frequency:145.800MHz (FM) SQL1 SSG:(-122dBm) 0.178μV SQL2 SSG:(-117dBm) 0.32μV	SSG	TX-RX	ANT	TX-RX	MNU key	Write	
	8) Frequency:222.100MHz (FM)(K) Frequency:230.100MHz (FM)(E,T) SQL1 SSG:(-122dBm) 0.178μV (K) SSG:(-118dBm) 0.28μV (E,T) SQL2 SSG:(-117dBm) 0.316μV (K) SSG:(-113dBm) 0.501μV (E,T)							

ADJUSTMENT

Item	Conditions	Measurement			Adjustment			Specifications/Remarks
		Test equipment	Unit	Terminal	Unit	Parts	Method	
Squelch write	9) Frequency:438.100MHz (FM) SQL1 SSG:(-125dBm) 0.126μV SQL2 SSG:(-120dBm) 0.22μV 10)Frequency:1270.100MHz (FM) SQL1 SSG:(-120dBm) 0.22μV SQL2 SSG:(-115dBm) 0.398μV	SSG	TX-RX	ANT	TX-RX	MNU key	Write	

Item	Conditions	Measurement			Adjustment			Specifications/Remarks
		Test equipment	Unit	Terminal	Unit	Parts	Method	
Squelch check	A Band 1) Frequency:145.050MHz Mode:FM SSG:(-125dBm) 0.126μV 2) SSG:(-135dBm) 0.04μV 3) Frequency:435.050MHz(E,T) Mode:FM SSG:(-123dBm) 0.158μV 4) SSG:(-130dBm) 0.071μV 5) Frequency:223.550MHz(K) SSG:(-123dBm) 0.158μV 6) SSG:(-130dBm) 0.071μV B Band 7) Frequency:14.100MHz Mode:AM SSG:(-108dBm) 0.891μV 8) SSG:(-118dBm) 0.28μV 9) Frequency:51.100MHz Mode:FM SSG:(-118dBm) 0.28μV 10)SSG:(-130dBm) 0.071μV 11)Frequency:120.100MHz Mode:AM SSG:(-108dBm) 0.891μV 12)SSG:(-115dBm) 0.4μV 13)Frequency:145.800MHz Mode:FM SSG:(-120dBm) 0.22μV 14)SSG:(-130dBm) 0.071μV 15)Frequency:230.100MHz(E,T) :222.100MHz(K) Mode:FM SSG:(-118dBm) 0.28μV 16)SSG:(-125dBm) 0.126μV 17)Frequency:438.100MHz Mode:FM SSG:(-123dBm) 0.158μV 18)SSG:(-130dBm) 0.071μV 19)Frequency:1270.100MHz Mode:FM SSG:(-118dBm) 0.28μV 20)SSG:(-128dBm) 0.089μV	SSG Oscilloscope	TX-RX (B/3)	ANT			Check	open squelch close squelch open squelch close squelch open squelch close squelch open squelch close squelch open squelch close squelch open squelch close squelch open squelch close squelch open squelch close squelch open squelch close squelch open squelch close squelch open squelch close squelch

ADJUSTMENT

Item	Conditions	Measurement			Adjustment			Specifications/Remarks
		Test equipment	Unit	Terminal	Unit	Parts	Method	
S-meter write	Switch to Service Setup mode and carry out the operations for item G. A-Band 1) Frequency:145.050MHz (FM) S1 SSG:(-124dBm) 0.141μV FULL SSG:(-109dBm) 2) Frequency:435.050MHz (E,T) Frequency:440.000MHz (K) S1 SSG:(-120dBm) 0.22μV FULL SSG:(-105dBm) 1.3μV 3) Frequency:223.550MHz (K only) S1 SSG:(-120dBm) 0.22μV FULL SSG:(-105dBm) 1.3μV B-Band 4) Frequency:0.800MHz (AM) S1 SSG:(-95dBm) 3.98μV FULL SSG:(-75dBm) 39.8μV 5) Frequency:14.100MHz (AM) S1 SSG:(-105dBm) 1.3μV FULL SSG:(-90dBm) 7.08μV 6) Frequency:51.100MHz (FM) S1 SSG:(-115dBm) 0.398μV FULL SSG:(-100dBm) 2.24μV 7) Frequency:120.100MHz (AM) S1 SSG:(-110dBm) 0.707μV FULL SSG:(-95dBm) 3.98μV 8) Frequency:145.800MHz (FM) S1 SSG:(-117dBm) 0.316μV FULL SSG:(-105dBm) 1.3μV 9) Frequency:222.100MHz (FM)(K) Frequency:230.100MHz (FM)(E,T) S1 SSG:(-117dBm) 0.32μV (K) SSG:(-113dBm) 0.501μV (E,T) FULL SSG:(-105dBm) 1.3μV (K) SSG:(-100dBm) 2.24μV (E,T) 10) Frequency:438.100MHz (FM) S1 SSG:(-120dBm) 0.22μV FULL SSG:-105dBm 1.3μV	SSG	TX-RX	ANT	TX-RX	MNU key	Write	

ADJUSTMENT

Item	Conditions	Measurement			Adjustment			Specifications/Remarks
		Test equipment	Unit	Terminal	Unit	Parts	Method	
S-meter write	11)Frequency:1270.100MHz (FM) S1 SSG:(-115dBm) 0.398μV FULL SSG:(-100dBm) 2.24μV	SSG	TX-RX	ANT	TX-RX	MNU key	Write	
	12)Frequency:90.100MHz (W-FM) S1 SSG:(-95dBm) 3.98μV FULL SSG:(-70dBm) 70.8μV							
	13)Frequency:200.100MHz (W-FM) S1 SSG:(-95dBm) 3.98μV FULL SSG:(-70dBm) 70.8μV							
	14)Frequency:500.100MHz (W-FM) S1 SSG:(-95dBm) 3.98μV FULL SSG:(-70dBm) 70.8μV							

Item	Conditions	Measurement			Adjustment			Specifications/Remarks
		Test equipment	Unit	Terminal	Unit	Parts	Method	
S-meter check	A-Band	SSG	TX-RX (B/3)	ANT		LCD	Check	One segment in S-meter lights
	1) Frequency:145.050MHz Mode:FM SSG:(-124dBm) 0.14μV±3dB							All segments in S-meter lights
	2) SSG:(-109dBm) 0.794μV±3dB							One segment in S-meter lights
	3) Frequency:435.050MHz(E,T) :440.000MHz(K) Mode:FM SSG:(-120dBm) 0.22μV±3dB							All segments in S-meter lights
	4) SSG:(-105dBm) 1.3μV±3dB							One segment in S-meter lights
	Frequency:223.550MHz(K) SSG:(-120dBm) 0.22μV±3dB SSG:(-105dBm) 1.3μV±3dB							All segments in S-meter lights
	B-Band							One segment in S-meter lights
	5) Frequency:0.800MHz Mode:AM SSG:(-95dBm) 3.98μV±3dB							All segments in S-meter lights
	6) SSG:(-75dBm) 39.8μV±3dB							One segment in S-meter lights
	7) Frequency:14.100MHz Mode:AM SSG:(-105dBm) 1.3μV±3dB							All segments in S-meter lights
	8) SSG:(-90dBm) 7.08μV±3dB							One segment in S-meter lights
	9) Frequency:51.100MHz Mode:FM SSG:(-115dBm) 0.4μV±3dB							All segments in S-meter lights
	10)SSG:(-100dBm) 2.24μV±3dB							One segment in S-meter lights
	11)Frequency:120.100MHz Mode:AM SSG:(-110dBm) 0.707μV±3dB							All segments in S-meter lights
12)SSG:(-95dBm) 3.98μV±3dB	One segment in S-meter lights							
13)Frequency:145.800MHz Mode:FM SSG:(-117dBm) 0.32μV±3dB	All segments in S-meter lights							

ADJUSTMENT

Item	Conditions	Measurement			Adjustment			Specifications/Remarks
		Test equipment	Unit	Terminal	Unit	Parts	Method	
S-meter check	14)SSG:(-105dBm) 1.3 μ V \pm 3dB	SSG	TX-RX (B/3)	ANT		LCD	Check	All segments in S-meter lights
	Frequency:222.100MHz(K) SSG:(-117dBm) 0.32 μ V \pm 3dB							One segment in S-meter lights
	Frequency:230.100MHz(E,T) SSG:(-113dBm) 0.5 μ V \pm 3dB							
	SSG:(-105dBm) 1.3 μ V \pm 3dB(K) SSG:(-100dBm) 2.24 μ V \pm 3dB(E,T)							All segments in S-meter lights
	15)Frequency:438.100MHz Mode:FM SSG:(-120dBm) 0.22 μ V \pm 3dB							One segment in S-meter lights
	16)SSG:(-105dBm) 1.3 μ V \pm 3dB							All segments in S-meter lights
	17)Frequency:1270.100MHz Mode:FM SSG:(-115dBm) 0.4 μ V \pm 3dB							One segment in S-meter lights
	18)SSG:(-100dBm) 2.24 μ V \pm 3dB							All segments in S-meter lights
	19)Frequency:90.100MHz Mode:WFM SSG:(-95dBm) 3.98 μ V \pm 3dB							One segment in S-meter lights
	20)SSG:(-70dBm) 70.8 μ V \pm 3dB							All segments in S-meter lights
	21)Frequency:200.100MHz Mode:WFM SSG:(-95dBm) 3.98 μ V \pm 3dB							One segment in S-meter lights
	22)SSG:(-70dBm) 70.8 μ V \pm 3dB							All segments in S-meter lights
	23)Frequency:500.100MHz Mode:WFM SSG:(-95dBm) 3.98 μ V \pm 3dB							One segment in S-meter lights
	24)SSG:(-70dBm) 70.8 μ V \pm 3dB							All segments in S-meter lights
High level input	A-Band	SSG Distortion meter Oscilloscope	TX-RX (B/3)	ANT SP			Check	38dB or more
	1) Frequency:145.050MHz SSG:(-53dBm) 501 μ V AF output:0.63V/8 Ω							34dB or more
	2) Frequency:440.000MHz(K) :435.050MHz(E,T) SSG:(-53dBm) 501 μ V AF output:0.63V/8 Ω							36dB or more
	3) Frequency:225.560MHz(K) SSG:(-53dBm) 60dB μ							36dB or more
	B-Band							32dB or more
	4) Frequency:145.050MHz SSG:(-53dBm) 501 μ V AF output:0.63V/8 Ω							34dB or more
5) Frequency:444.050MHz(K) :435.050MHz(E,T) SSG:(-53dBm) 501 μ V AF output:0.63V/8 Ω								
6) Frequency:222.050MHz(K) SSG:(-53dBm) 501 μ V								
Sensitivity check	A-Band							12dB SINAD or more
	1) Frequency:144.000MHz(K)							
	2) Frequency:146.050MHz(K) Frequency:145.050MHz(E,T)							
	3) Frequency:147.990MHz(K) Frequency:145.990MHz(E,T)							
	4) Frequency:444.050MHz(K) Frequency:435.050MHz(E,T)							
	5) Frequency:438.000MHz(K) Frequency:430.040MHz(E,T)							

ADJUSTMENT

Item	Conditions	Measurement			Adjustment			Specifications/Remarks
		Test equipment	Unit	Terminal	Unit	Parts	Method	
Sensitivity check	6) Frequency:449.990MHz(K) Frequency:439.990MHz(E,T) Mode:FM SSG:(-121dBm) 0.2μV AF output:0.63V/8Ω	SSG Distortion meter Oscilloscope	TX-RX (B/3)	ANT SP			Check	12dB SINAD or more
	7) Frequency:223.550MHz(K) SSG:(-120dBm) 0.22μV							
	8) Frequency:216.000MHz(K) SSG:(-103dBm) 1.58μV							
	9) Frequency:259.990MHz(K) SSG:(-103dBm) 1.58μV							
	B-Band 10)Frequency:146.100MHz Mode:FM SSG:(-117dBm) 0.32μV AF output:0.63V/8Ω							
	11)Frequency:118.100MHz Mode:FM SSG:(-93dBm) 5.01μV AF output:0.63V/8Ω							
	12)Frequency:173.900MHz Mode:FM SSG:(-100dBm) 2.24μV AF output:0.63V/8Ω							
	13)Frequency:51.100MHz Mode:FM SSG:(-110dBm) 0.707μV AF output:0.63V/8Ω							
	14)Frequency:144.000MHz 15)Frequency:147.950MHz Mode:FM SSG:(-117dBm) 0.32μV AF output:0.63V/8Ω							
	16)Frequency:222.050MHz Frequency:224.950MHz Mode:FM SSG:(-110dBm) 0.707μV AF output:0.63V/8Ω							
	17)Frequency:438.100MHz 18)Frequency:444.050MHz 19)Frequency:449.950MHz Mode:FM SSG:(-117dBm) 0.32μV AF output:0.63V/8Ω							
	20)Frequency:850.100MHz Mode:FM SSG:(-100dBm) 2.24μV AF output:0.63V/8Ω							
	21)Frequency:1240.050MHz 22)Frequency:1270.050MHz 23)Frequency:1299.950MHz Mode:FM SSG:(-110dBm) 0.707μV AF output:0.63V/8Ω							
	24)Frequency:90.100MHz Mode:FM SSG:(-100dBm) 2.24μV AF output:0.63V/8Ω							

ADJUSTMENT

Item	Conditions	Measurement			Adjustment			Specifications/Remarks
		Test equipment	Unit	Terminal	Unit	Parts	Method	
Sensitivity check	25) Frequency: 107.900MHz Mode: FM SSG: (-93dBm) 5.01μV AF output: 0.63V/8Ω	SSG Distortion meter Oscilloscope	TX-RX (B/3)	ANT			Check	12dB SINAD or more
	26) Frequency: 500.100MHz Mode: FM SSG: (-100dBm) 2.24μV AF output: 0.63V/8Ω			SP				
	27) Frequency: 90.100MHz Mode: WFM SSG: (-78dBm) 28.2μV AF output: 0.63V/8Ω							
	For the internal bar antenna connect SSG output to the Loop ANTENNA as shown in figure *. 27) Frequency: 1080KHz Mode: AM S/N Mod: 60% SSG: (0dBm) 2.24mV		AM Loop ANTENNA			10dB S/N or more		
AF distortion check	A-Band 1) Frequency: 145.050MHz SSG: (-53dBm) 501μV AF output: 0.63V/8Ω	SSG Distortion meter Oscilloscope	TX-RX (B/3)	ANT SP			Check	5% or less
	B-Band 2) Frequency: 146.050MHz SSG: (-53dBm) 501μV AF output: 0.63V/8Ω							10% or less

ADJUSTMENT

Item	Conditions	Measurement			Adjustment			Specifications/Remarks					
		Test equipment	Unit	Terminal	Unit	Parts	Method						
Power Write [6.0V] Battery	15)Power:Low Frequency:449.995MHz (K) Frequency:439.995MHz (E,T)	Power meter Am meter		ANT		MNU key	Write						
	16)Power:EL Frequency:444.000MHz (K) Frequency:435.000MHz (E,T)				MNU key	Write							
	17)Power:EL Frequency:438.050MHz (K) Frequency:430.050MHz (E,T)				MNU key	Write							
	18)Power:EL Frequency:449.995MHz (K) Frequency:439.995MHz (E,T)				MNU key	Write							
	19)Power:Hi Frequency:224.000MHz (K) Transmission									0.5W ± 0.1W 1.2A or less			
	20)Power:Hi Frequency:222.050MHz (K) Transmission									0.5W ± 0.1W 1.2A or less			
	21)Power:Hi Frequency:224.995MHz (K) Transmission									0.5W ± 0.1W 1.2A or less			
	22)Power:Low Frequency:224.000MHz (K) Transmission									0.3W ± 0.1W 0.8A or less			
	23)Power:Low Frequency:222.050MHz (K)								MNU key	Write			
	24)Power:Low Frequency:224.995MHz								MNU key	Write			
	25)Power:EL Frequency:224.000MHz (K)								MNU key	Write			
	26)Power:EL Frequency:222.050MHz (K)								MNU key	Write			
	27)Power:EL Frequency:224.995MHz (K)								MNU key	Write			
	Power write [7.4V] Battery		Battery Terminal:7.4V		Power meter Am meter		ANT			Tuning control	Write Check	2.0A 4.7~4.8W 2.0A 4.7~4.8W 2.0A 4.7~4.8W 0.5W ± 0.1W 0.9A 75mW ± 25mW 0.6A	
	1) Power:Hi Frequency:146.000MHz (K) Frequency:145.000MHz (E,T) Transmission												
	2) Power:Hi Frequency:144.050MHz Transmission												
	3) Power:Hi Frequency:147.995MHz (K) Frequency:145.995MHz (E,T) Transmission												
	4) Power:Low Frequency:146.000MHz (K) Frequency:145.000MHz (E,T) Transmission												
	5) Power:Low Frequency:144.050MHz										MNU key		Write
	6) Power:Low Frequency:147.995MHz (K) Frequency:145.995MHz (E,T)										MNU key		Write
	7) Power:EL Frequency:146.000MHz (K) Frequency:145.000MHz (E,T) Transmission								Tuning control MNU key	Write check			

ADJUSTMENT

Item	Conditions	Measurement			Adjustment		Specifications/Remarks		
		Test equipment	Unit	Terminal	Unit	Parts		Method	
Power write [7.4V] Battery	8) Power:EL Frequency:144.050MHz (K)	Power meter Am meter		ANT		MNU key	Write	2.0A 4.7~4.8W 2.0A 4.7~4.8W 2.0A 4.7~4.8W 0.5W ± 0.1W 0.9A or less 75mW ± 25mW 0.6A or less 2.0A 4.7~4.8W 2.0A 4.7~4.8W 2.0A 4.7~4.8W 0.5W ± 0.1W 0.9A or less 75mW ± 25mW 0.6A or less	
	9) Power:EL Frequency:147.995MHz (K) Frequency:145.995MHz (E,T)					MNU key	Write		
	10)Power:Hi Frequency:444.000MHz (K) Frequency:435.000MHz (E, T) Transmission						Tuning control MNU key		Write check
	11)Power:Hi Frequency:438.050MHz (K) Frequency:430.050MHz (E,T) Transmission						Tuning control MNU key		Write check
	12)Power:Hi Frequency:449.995MHz (K) Frequency:439.995MHz (E, T) Transmission						Tuning control MNU key		Write check
	13)Power:Low Frequency:444.000MHz (K) Frequency:435.000MHz (E, T) Transmission						Tuning control MNU key		Write check
	14)Power:Low Frequency:438.050MHz (K) Frequency:430.050MHz (E, T)						MNU key		Write
	15)Power:Low Frequency:449.995MHz (K) Frequency:439.995MHz (E, T)						MNU key		Write
	16)Power:EL Frequency:444.000MHz (K) Frequency:435.000MHz (E, T) Transmission						Tuning control MNU key		Write check
	17)Power:EL Frequency:438.050MHz (K) Frequency:430.050MHz (E, T)						MNU key		Write
	18)Power:EL Frequency:449.995MHz (K) Frequency:439.995MHz (E, T)						MNU key		Write
	19)Power:Hi Frequency:224.000MHz (K) Transmission						Tuning control MNU key		Write check
	20)Power:Hi Frequency:222.050MHz (K) Transmission								
	21)Power:Hi Frequency:224.995MHz (K) Transmission								
	22)Power:Low Frequency:224.000MHz (K) Transmission						Tuning control MNU key		Write check
	23)Power:Low Frequency:222.050MHz (K)						MNU key		Write
	24)Power:Low Frequency:224.995MHz (K)						MNU key		Write
	25)Power:EL Frequency:224.000MHz (K) Transmission						Tuning control MNU key		Write check
	26)Power:EL Frequency:222.050MHz (K)						MNU key		Write

ADJUSTMENT

Item	Conditions	Measurement			Adjustment			Specifications/Remarks
		Test equipment	Unit	Terminal	Unit	Parts	Method	
Power write [13.8V] DC-IN	16)Power:EL Frequency:444.000MHz (K) Frequency:435.000MHz (E, T) Transmission	Power meter Am meter		ANT		Tuning control	Write check	0.5W ± 0.05W 0.9A or less 2.0A 4.7~4.8W 2.0A 4.7~4.8W 2.0A 4.7~4.8W 2.0W ± 0.1W 1.8A or less 0.5W ± 0.05W 0.9A or less
	17)Power:EL Frequency:438.050MHz (K) Frequency:430.050MHz (E, T)					MNU key	Write	
	18)Power:EL Frequency:444.995MHz (K) Frequency:439.995MHz (E, T)					MNU key	Write	
	19)Power:Hi Frequency:224.000MHz (K) Transmission					Tuning control	Write check	
	20)Power:Hi Frequency:222.050MHz (K) Transmission							
	21)Power:Hi Frequency:224.995MHz (K) Transmission							
	22)Power:Low Frequency:224.000MHz (K) Transmission							
	23)Power:Low Frequency:222.050MHz (K)					MNU key	Write	
	24)Power:Low Frequency:224.995MHz (K)					MNU key	Write	
	25)Power:EL Frequency:224.000MHz (K) Transmission					Tuning control MNU key		
	26)Power:EL Frequency:222.050MHz (K)					MNU key	Write	
	27)Power:EL Frequency:224.995MHz (K)					MNU key	Write	

Item	Conditions	Measurement			Adjustment			Specifications/Remarks						
		Test equipment	Unit	Terminal	Unit	Parts	Method							
Power check [6.0V] Battery	Battery Terminal:6.0V Power:Hi	DC.A Power meter	TX-RX (B/3)	ANT			Check	0.3W~0.7W 0.9A or less						
	1) Frequency:146.000MHz (K) Frequency:145.000MHz (E, T)													
	2) Frequency:144.050MHz 3) Frequency:147.995MHz (K) Frequency:145.995MHz (E, T) Transmission													
	Power:Hi													0.3W~0.7W 0.9A or less
	4) Frequency:444.000MHz (K) Frequency:435.000MHz (E, T)													
	5) Frequency:438.050MHz (K) Frequency:430.050MHz (E, T)													
	6) Frequency:449.995MHz (K) Frequency:439.995MHz (E, T) Transmission													0.3W~0.7W 0.9A or less
	Power:Hi													
	7) Frequency:224.000MHz (K) 8) Frequency:222.050MHz (K) 9) Frequency:224.995MHz (K)													

ADJUSTMENT

Item	Conditions	Measurement			Adjustment			Specifications/Remarks
		Test equipment	Unit	Terminal	Unit	Parts	Method	
Power check [7.4V] Battery	Battery Terminal:7.4V Power:Hi 1) Frequency:146.000MHz (K) Frequency:145.000MHz (E,T) 2) Frequency:144.050MHz 3) Frequency:147.995MHz (K) Frequency:145.995MHz (E,T) Transmission	DC.A Power meter	TX-RX (B/3)	ANT			Check	4.5W~5.4W 2.1A or less
	Power:Low 4) Frequency:146.000MHz (K) Frequency:145.000MHz (E,T) Transmission							0.3W~0.7W 0.9A or less
	5) Frequency:144.050MHz 6) Frequency:147.995MHz (K) Frequency:145.995MHz (E,T) Transmission							0.3W~0.7W
	Power:EL 7) Frequency:146.000MHz (K) Frequency:145.000MHz (E,T) Transmission							50mW~100mW 0.6A or less
	8) Frequency:144.050MHz 9) Frequency:147.995MHz (K) Frequency:145.995MHz (E,T) Transmission							50mW~100mW
	Power:Hi 10)Frequency:435.000MHz 11)Frequency:438.050MHz (K) Frequency:430.050MHz (E,T) 12)Frequency:449.995MHz (K) Frequency:439.995MHz (E,T) Transmission							4.5W~5.4W 2.1A or less
	Power:Low 13)Frequency:444.000MHz (K) Frequency:435.000MHz (E,T) Transmission							0.3W~0.7W 0.9A or less
	14)Frequency:438.050MHz (K) Frequency:430.050MHz (E,T) 15)Frequency:449.995MHz (K) Frequency:439.995MHz (E,T) Transmission							0.3W~0.7W
	Power:EL 16)Frequency:444.000MHz (K) Frequency:435.000MHz (E,T) Transmission							50mW~100mW 0.6A or less
	17)Frequency:438.050MHz (K) Frequency:430.050MHz (E,T) 18)Frequency:449.995MHz (K) Frequency:439.995MHz (E,T) Transmission							50mW~100mW
	Power:Hi 19)Frequency:224.000MHz (K) Transmission 20)Frequency:222.050MHz (K) Transmission 21)Frequency:224.995MHz (K) Transmission							4.5W~5.4W 2.1A or less

ADJUSTMENT

Item	Conditions	Measurement			Adjustment			Specifications/Remarks
		Test equipment	Unit	Terminal	Unit	Parts	Method	
Power check [7.4V] Battery	Power:Low 22)Frequency:224.000MHz (K) 23)Frequency:222.050MHz (K) 24)Frequency:224.995MHz (K)	DC.A Power meter	TX-RX (B/3)	ANT			Check	0.3W~0.7W 0.9A or less
	Power:EL 25)Frequency:224.000MHz (K) 26)Frequency:222.050MHz (K) 27)Frequency:224.995MHz (K)							50mW~100mW
Power check [13.8V] DC-IN	DC-IN:13.8V Power:Hi 1) Frequency:146.000MHz (K) Frequency:145.000MHz (E,T) 2) Frequency:144.050MHz 3) Frequency:147.995MHz (K) Frequency:145.995MHz (E,T) Transmission							4.5W~5.4W 2.1A or less
	Power:Low 4) Frequency:146.000MHz (K) Frequency:145.000MHz (E,T) Transmission							1.6W~2.4W 1.8A or less
	5) Frequency:144.050MHz (E,T) 6) Frequency:147.995MHz (K) Frequency:145.995MHz (E,T) Transmission							1.6W~2.4W
	Power:EL 7) Frequency:146.000MHz (K) Frequency:145.000MHz (E,T) Transmission							0.3W~0.7W 0.9A or less
	8) Frequency:144.050MHz (E,T) 9) Frequency:147.995MHz (K) Frequency:145.995MHz (E,T) Transmission							0.3W~0.7W
	Power:Hi 10)Frequency:444.000MHz (K) Frequency:435.000MHz (E,T) 11)Frequency:438.050MHz (K) Frequency:430.050MHz (E,T) 12)Frequency:449.995MHz (K) Frequency:439.995MHz (E,T) Transmission							4.5W~5.4W 2.1A or less
	Power:Low 13)Frequency:444.000MHz (K) Frequency:435.000MHz (E,T) Transmission							1.6W~2.4W 1.8A or less
	14)Frequency:438.050MHz (K) Frequency:430.050MHz (E,T) 15)Frequency:449.995MHz (K) Frequency:439.995MHz (E,T) Transmission							1.6W~2.4W
	Power:EL 16)Frequency:444.000MHz (K) Frequency:435.000MHz (E,T) Transmission							0.3W~0.7W 0.9A or less
	17)Frequency:438.050MHz (K) Frequency:430.050MHz (E,T) 18)Frequency:449.995MHz (K) Frequency:439.995MHz (E,T) Transmission							0.3W~0.7W

ADJUSTMENT

Item	Conditions	Measurement			Adjustment			Specifications/Remarks
		Test equipment	Unit	Terminal	Unit	Parts	Method	
Power check [138V] DC-IN	Power:Hi 19)Frequency:224.000MHz (K) Transmission 20)Frequency:222.050MHz (K) Transmission 21)Frequency:224.995MHz (K) Transmission	DC.A Power meter	TX-RX (B/3)	ANT			Check	4.5W~5.4W 2.1A or less
	Power:Low 22)Frequency:224.000MHz (K) Transmission 23)Frequency:222.050MHz (K) Transmission 24)Frequency:224.995MHz (K) Transmission							1.6W~2.4W 1.8A or less
	Power:EL 25)Frequency:224.000MHz (K) Transmission 26)Frequency:222.050MHz (K) Transmission 27)Frequency:224.995MHz (K) Transmission							0.3W~0.7W 0.9A or less

Item	Conditions	Measurement			Adjustment			Specifications/Remarks
		Test equipment	Unit	Terminal	Unit	Parts	Method	
MAX DEV	Switch to Service Setup mode and carry out the operations for item J. 1) Frequency:146.000MHz (K) Frequency:145.000MHz (E,T) AG:1KHz/80mV Mod.Analyzer 15KHz, LPF,FM+/-Peak Transmission 2) Frequency:144.050MHz 3) Frequency:147.995MHz (K) Frequency:145.995MHz (E,T) 4) Frequency:444.000MHz (K) Frequency:435.000MHz (E,T) Transmission 5) Frequency:438.050MHz (K) Frequency:430.050MHz (E,T) Transmission 6) Frequency:449.995MHz (K) Frequency:439.995MHz (E,T) Transmission 7) Frequency:224.000MHz (K) Transmission 8) Frequency:222.050MHz (K) 9) Frequency:224.995MHz (K)	Oscilloscope Linear detector Power meter		ANT			Tuning control MNU key MNU key Write Write Tuning control MNU key MNU key Write Write	4KHz ± 200Hz
MIC Sencitivity	1) Frequency:146.000MHz (K) Frequency:145.000MHz (E,T) AG:1KHz/7mV Transmission 2) Frequency:444.000MHz (K) Frequency:435.000MHz (E,T) 3) Frequency:224.000MHz (K)	Linear detector Power meter Oscilloscope AG		ANT			Check	2.2KHz~3.6KHz
								2.2KHz~3.6KHz
								2.2KHz~3.6KHz

ADJUSTMENT

Item	Conditions	Measurement			Adjustment			Specifications/Remarks														
		Test equipment	Unit	Terminal	Unit	Parts	Method															
CTCSS Dev.	Switch to Service Setup mode and carry out the operations for item K. 1) Frequency:146.000MHz (K) Frequency:145.000MHz (E,T) TONE:151.4HZ Transmission 2) Frequency:144.050MHz 3) Frequency:147.995MHz (K) Frequency:145.995MHz (E,T) 4) Frequency:444.000MHz (K) Frequency:435.000MHz (E,T) Transmission 5) Frequency:438.050MHz (K) Frequency:430.050MHz (E,T) Transmission 6) Frequency:449.995MHz (K) Frequency:439.995MHz (E,T) Transmission 7) Frequency:224.000MHz (K) 8) Frequency:222.050MHz (K) 9) Frequency:224.995MHz (K)	Power meter Linear detector Oscilloscope		ANT		Tuning control MNU key	Write	0.8KHz ± 50Hz														
									Power meter Linear detector Oscilloscope		ANT		MNU key MNU key	Write Write	0.8KHz ± 50Hz							
																Power meter Linear detector Oscilloscope		ANT		MNU key MNU key	Write Write	0.8KHz ± 50Hz
									Power meter Linear detector Oscilloscope		ANT		MNU key MNU key	Write Write	0.8KHz ± 50Hz							
																Power meter Linear detector Oscilloscope		ANT		MNU key MNU key	Write Write	0.8KHz ± 50Hz
		Power meter Linear detector Oscilloscope		ANT		MNU key MNU key	Write Write	0.8KHz ± 50Hz														
		9600bps Dev.	Switch to Service Setup mode and carry out the operations for item M. 1) Frequency:146.000MHz (K) Frequency:145.000MHz (E,T) AG:1KHz/0.566V Transmission 2) Frequency:144.050MHz 3) Frequency:147.995MHz (K) Frequency:145.995MHz (E,T) 4) Frequency:444.000MHz (K) Frequency:435.000MHz (E,T) Transmission 5) Frequency:438.050MHz (K) Frequency:430.050MHz (E,T) Transmission 6) Frequency:449.995MHz (K) Frequency:439.995MHz (E,T) Transmission 7) Frequency:224.000MHz (K) 8) Frequency:222.050MHz (K) 9) Frequency:224.995MHz (K)	Power meter Linear detector Oscilloscope		ANT		Tuning control MNU key MNU key MNU key MNU key Tuning control MNU key MNU key MNU key	Write Write Write Write Write Write Write	2.2KHz ± 500Hz 2.2KHz ± 500Hz												
											Power meter Linear detector Oscilloscope		ANT		MNU key MNU key MNU key	Write Write Write	2.2KHz ± 500Hz					
Power meter Linear detector Oscilloscope																		ANT		MNU key MNU key	Write Write	2.2KHz ± 500Hz
Power meter Linear detector Oscilloscope											ANT		MNU key MNU key	Write Write	2.2KHz ± 500Hz							
																Power meter Linear detector Oscilloscope		ANT		MNU key MNU key MNU key	Write Write Write	2.2KHz ± 500Hz

Item	Conditions	Measurement			Adjustment			Specifications/Remarks
		Test equipment	Unit	Terminal	Unit	Parts	Method	
DTMF Dev. check [7.4V]	1) Frequency:146.000MHz (K) 2) Frequency:145.000MHz (E,T)	AG AF.V.M Power meter	TX-RX (B/3)	ANT MIC			Check	2.0KHz~4.2KHz
Protection check [7.4V]	1) Frequency:146.000MHz (K) Frequency:145.000MHz (E,T) 2) Frequency:444.000MHz (K) Frequency:435.000MHz (E,T) ANT:Open Transmission	DC.A Linear detector osilloscope						

TX-RX UNIT (X57-636X-XX) (A/3) Component Side View
CONTROL SECTION

CONTROL SECTION(A/3)
(Component side)

Ref.No.	Address
IC719	3J
IC720	5I
Q702	9K
Q705	3L
Q723	10O
D702	3G
D703	3F
D704	3G
D706	3I
D707	3K
D708	4G
D710	10K
D711	10J
D712	6O
D713	7O
D714	3M
D715	3N
D716	10N
D717	10L
D720	8E
D721	7E
D722	8D
D723	7D
D724	5E
D725	5D

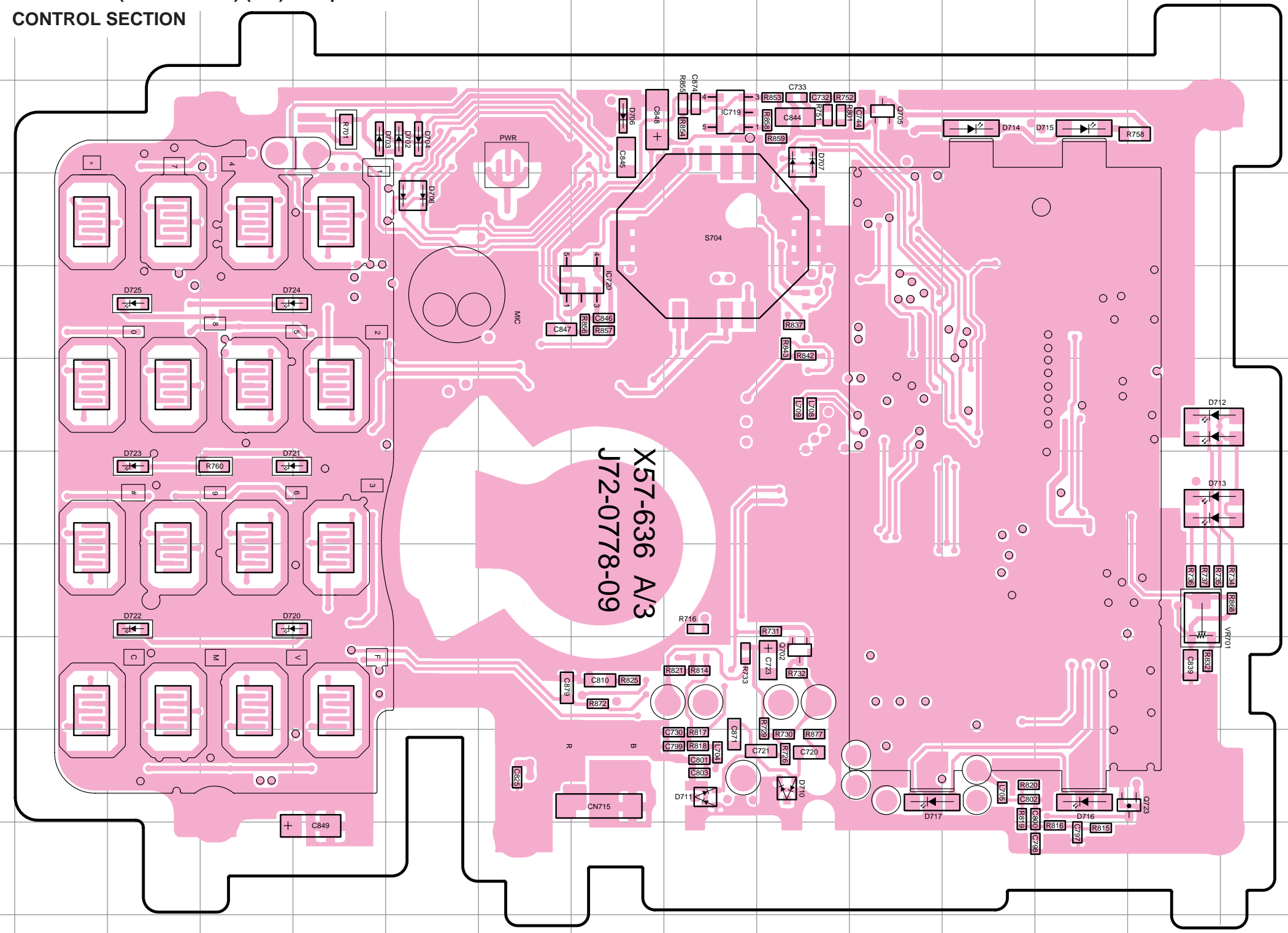

DTC114EE

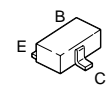

2SJ347
2SK1830

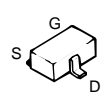

NJM2107F

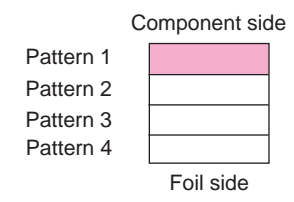
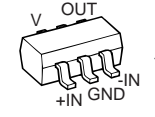

TH-F6A/F7E

PC BOARD VIEW

TX-RX UNIT (X57-636X-XX) (A/3) Foil Side View

CONTROL SECTION

Downloaded by
RadioAmateur.EU

CONTROL SECTION(A/3)
(Foil side)

Ref. No.	Address
IC701	8I
IC702	8G
IC703	8M
IC704	3G
IC705	6G
IC706	6N
IC707	8F
IC708	4J
IC709	4J
IC710	3I
IC711	7M
IC712	4K
IC713	8L
IC714	8N
IC715	7N
IC717	7N
IC718	8M
Q701	7H
Q703	6I
Q704	7E
Q706	9E
Q707	9G
Q708	8F
Q709	9K
Q710	9M
Q712	4J
Q713	5M
Q714	7E
Q715	3N
Q716	8H
Q719	6M
Q720	5K
Q721	6K
Q722	6K
Q725	9J
Q726	7M
Q727	8O
Q728	10N
Q729	9L
D705	8H
D709	7H
D718	8M
D719	3K
D726	9K
D727	5I
D730	8L
D731	9E
D732	9E

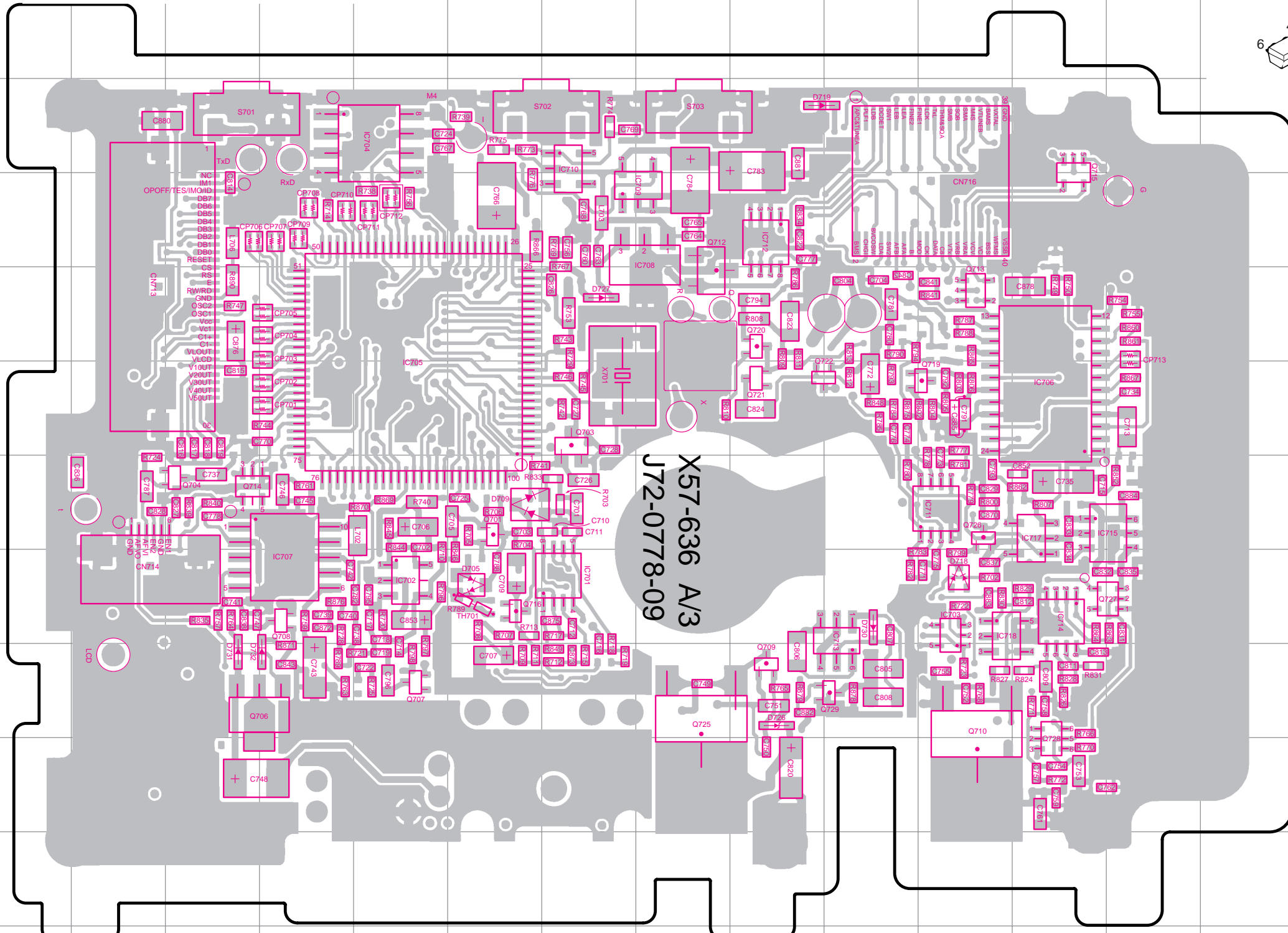

LM2681

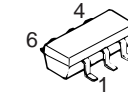

LMC7101BIM5

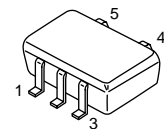

XC6202P402PR

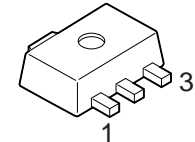

M62364FP

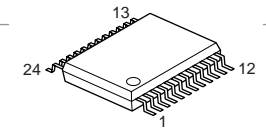

TA75W01FU

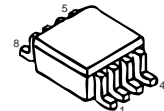

AT25128N10SI27

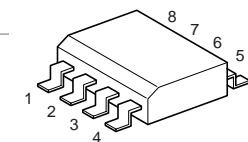

NJM2107F

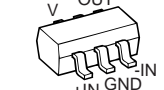

2SC4617



2SB1184

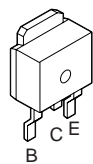

2SC4081

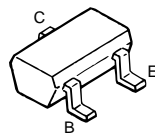

UMA10N
UMX2N

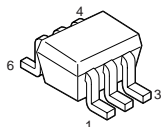

2SC4919

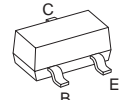

RN47A5

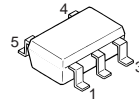

TA75W558FU
TC4W53FU

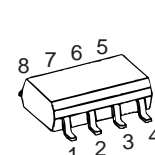

2SJ347
2SK1830

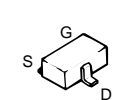

RN5VL37A
TC7S66FU

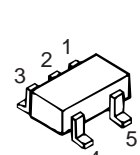

TA7368F

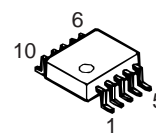

PST9130NR

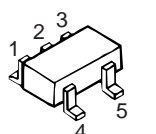

TK11930M

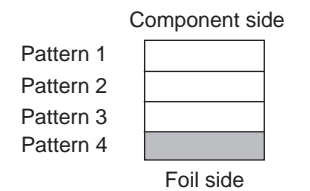
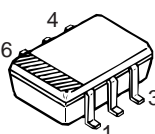

TX-RX UNIT (X57-636X-XX) (A/3) Component Side View + Foil Side View CONTROL SECTION

CONTROL SECTION (A/3) (Component + Foil side)

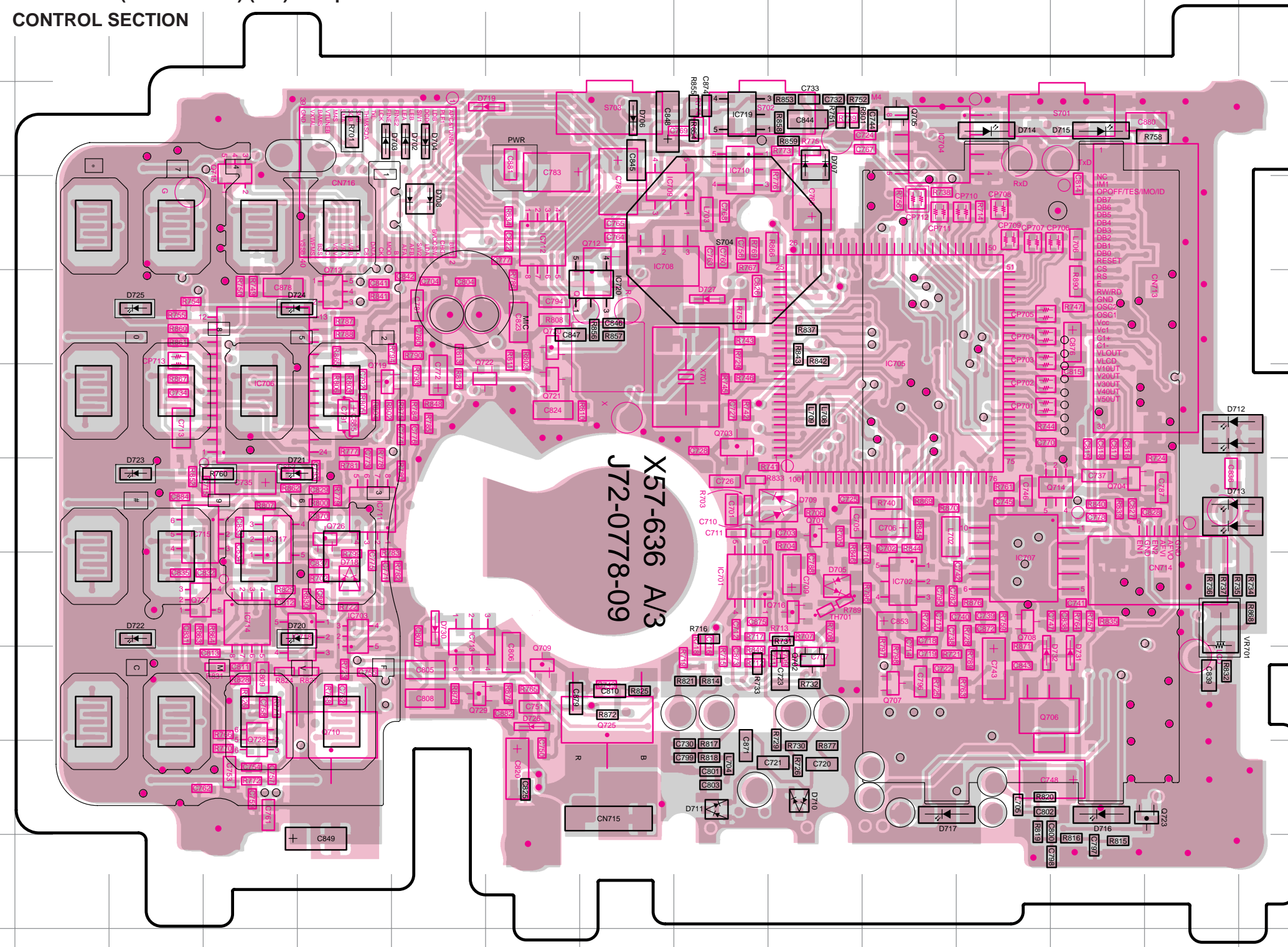

Ref. No.	Address
IC701	8K
IC702	8M
IC703	8G
IC704	3M
IC705	6M
IC706	6F
IC707	8N
IC708	4J
IC709	4J
IC710	3K
IC711	7G
IC712	4I
IC713	8H
IC714	8F
IC715	7F
IC717	7F
IC718	8G
IC719	3J
IC720	5I
Q701	7L
Q702	9K
Q703	6K
Q704	7O
Q705	3L
Q706	9O
Q707	9M
Q708	8N
Q709	9I
Q710	9G
Q712	4J
Q713	5G
Q714	7O
Q715	3F
Q716	8L
Q719	6G
Q720	5I
Q721	6I
Q722	6I
Q723	10O
Q725	9J
Q726	7G
Q727	8E
Q728	10F
Q729	9H
D702	3G
D703	3F
D704	3G
D705	8L
D706	3I
D707	3K
D708	4G
D709	7L
D710	10K
D711	10J
D712	6O
D713	7O
D714	3M
D715	4M
D716	10N
D717	10L
D718	8G
D719	3I
D720	8E
D721	7E
D722	8D
D723	7D
D724	5E
D725	5D
D726	9I
D727	5K
D730	8H
D731	9O
D732	9O

- DTC114EE
2SC4617
- 2SB1184
- 2SC4081
- UMA10N
UMX2N
- 2SC4919
- RN47A5

- M62364FP
- TA75W01FU
- AT25128N10SI27
- NJM2107F

- TA75W558FU
TC4W53FU
- 2SJ347
2SK1830
2SK3019
- RN5VL37A
TC7S66FU
- TA7368F
- PST9130NR
- TK11930M
- LM2681
- LMC7101BIM5
- XC6202P402PR

● Connect 1 and 4.

Component side

Foil side

Pattern 1

Pattern 2

Pattern 3

Pattern 4

TH-F6A/F7E PC BOARD VIEW

TX-RX UNIT (X57-686X-XX) (B/3) Component Side View

Downloaded by
RadioAmateur.EU

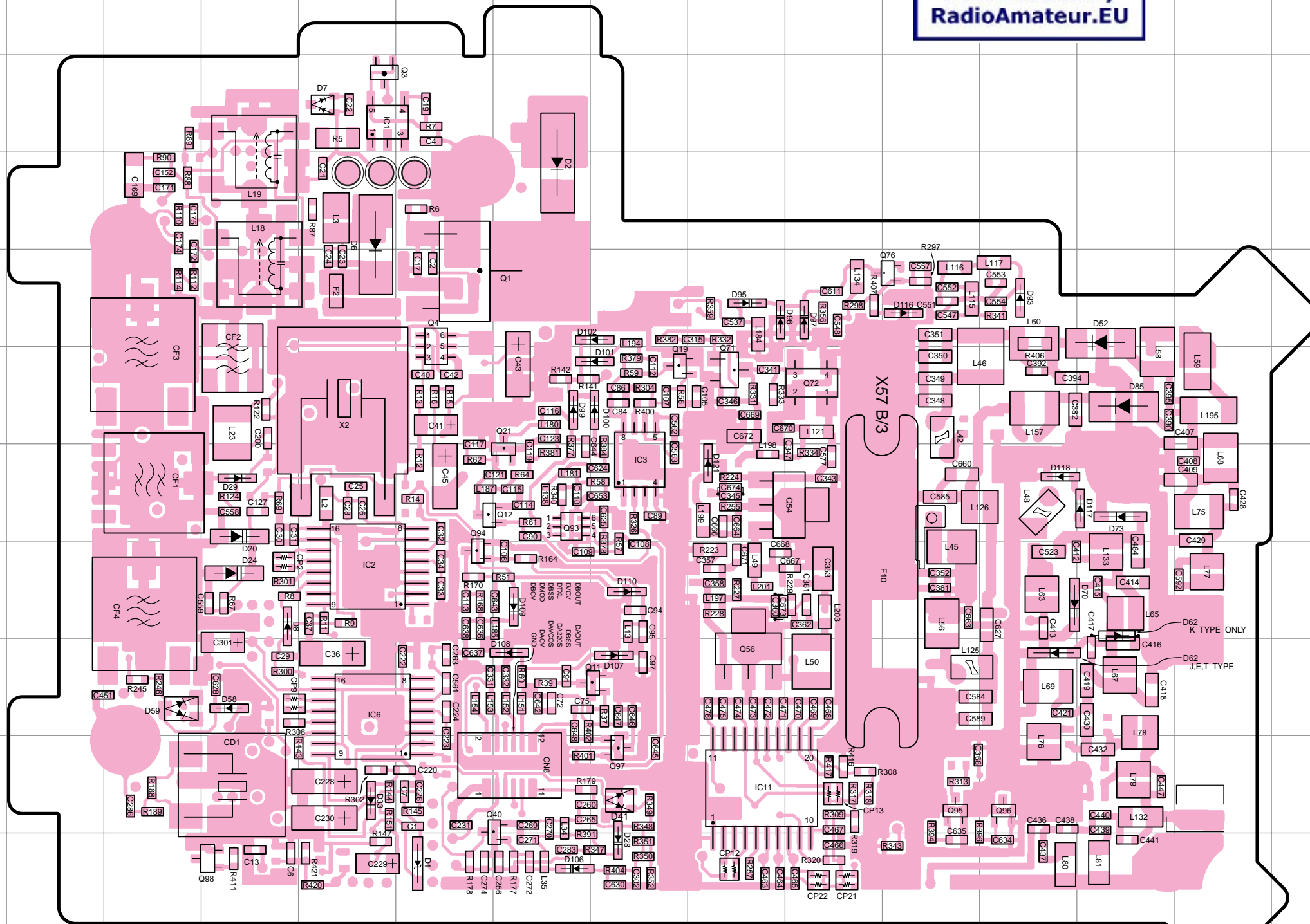

TX-RX UNIT(B/3)
(Component side)

Ref. No.	Address
IC1	3E
IC2	8E
IC3	7H
IC6	9E
IC11	10I
Q1	5F
Q3	3E
Q4	5F
Q11	9G
Q12	7F
Q19	6H
Q21	7G
Q40	10F
Q56	9I
Q71	6I
Q72	6J
Q76	5K
Q93	7G
Q94	8F
Q95	10K
Q96	10L
Q97	10H
Q98	11D
D1	11F
D2	4G
D6	4E
D7	3E
D8	8D
D20	7D
D24	8D
D28	11H
D29	7D
D33	10E
D41	10H
D52	5M
D52	5M
D54	7I
D58	9D
D59	9C
D62	8M(K)
D62	9L(J,E,T)
D70	8L
D73	7M
D85	6M
D93	5L
D95	5I
D96	5I
D97	5J
D99	6G
D100	6H
D101	6H
D102	5H
D106	11G
D107	9H
D108	9G
D109	8G
D110	8H
D116	5K
D117	7L
D118	7L
D121	7I

DTA143ZE
DTC144EE
2SC4226
2SC4725
2SC5009
2SC5108

2SD1760

2SC5192

2SK1830

HN1K02FU

MT6C03AE

LM3420-8.4

LMX2326TMX

BU2099FV

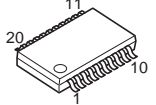
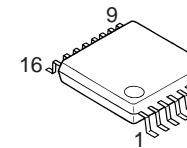
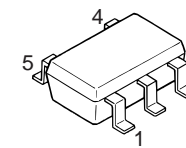
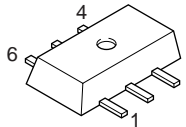
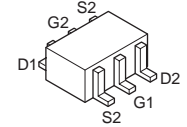
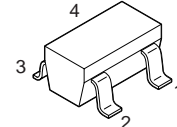
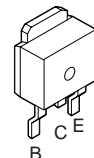
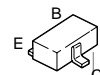

Pattern 1
Pattern 2
Pattern 3
Pattern 3

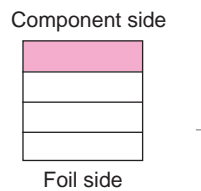

TX-RX UNIT (X57-686X-XX) (B/3) Foil Side View

TX-RX UNIT(B/3) (Foil side)

Ref. No.	Address	Ref. No.	Address
IC4	6P	D4	4N
IC5	4P	D5	5N
IC7	8P	D25	5Q
IC8	6F	D32	8L
IC9	8F	D44	8G
IC10	8L	D45	10G
Q2	4N	D49	6G
Q5	5N	D51	6G
Q8	11M	D53	8H
Q14	8N	D54	8H
Q15	8M	D57	7L
Q17	10N	D60	8Q
Q22	8Q	D63	10M
Q23	7Q	D65	8L
Q24	6Q	D67	10L
Q25	5O	D68	8L
Q26	6O	D69	10H
Q27	6P	D71	10L
Q28	6L	D72	8K
Q29	8P	D74	8K
Q30	5L	D75	7K
Q32	7Q	D76	6J
Q41	10N	D77	6J
Q43	9O	D78	8L
Q44	7P	D80	7K
Q45	9M	D81	7K
Q46	11I	D82	9G
Q47	10G	D83	8K
Q48	9Q	D87	6I
Q49	6F	D88	5K
Q50	7F	D89	5K
Q51	11G	D90	6K
Q52	8Q	D91	7L
Q53	10H	D94	5H
Q55	7J	D103	7L
Q57	8I	D104	9H
Q58	8M	D112	8G
Q59	10Q	D112	9H
Q62	10H	D113	6I
Q63	6K	D115	5I
Q64	5J	D119	9J
Q65	4M	D120	7J
Q66	10G	D123	9L
Q68	9G	D124	9L
Q73	5H	D125	8L
Q74	5J	D126	8G
Q92	10J		
Q99	10J		
Q100	3P		
Q114	7G		

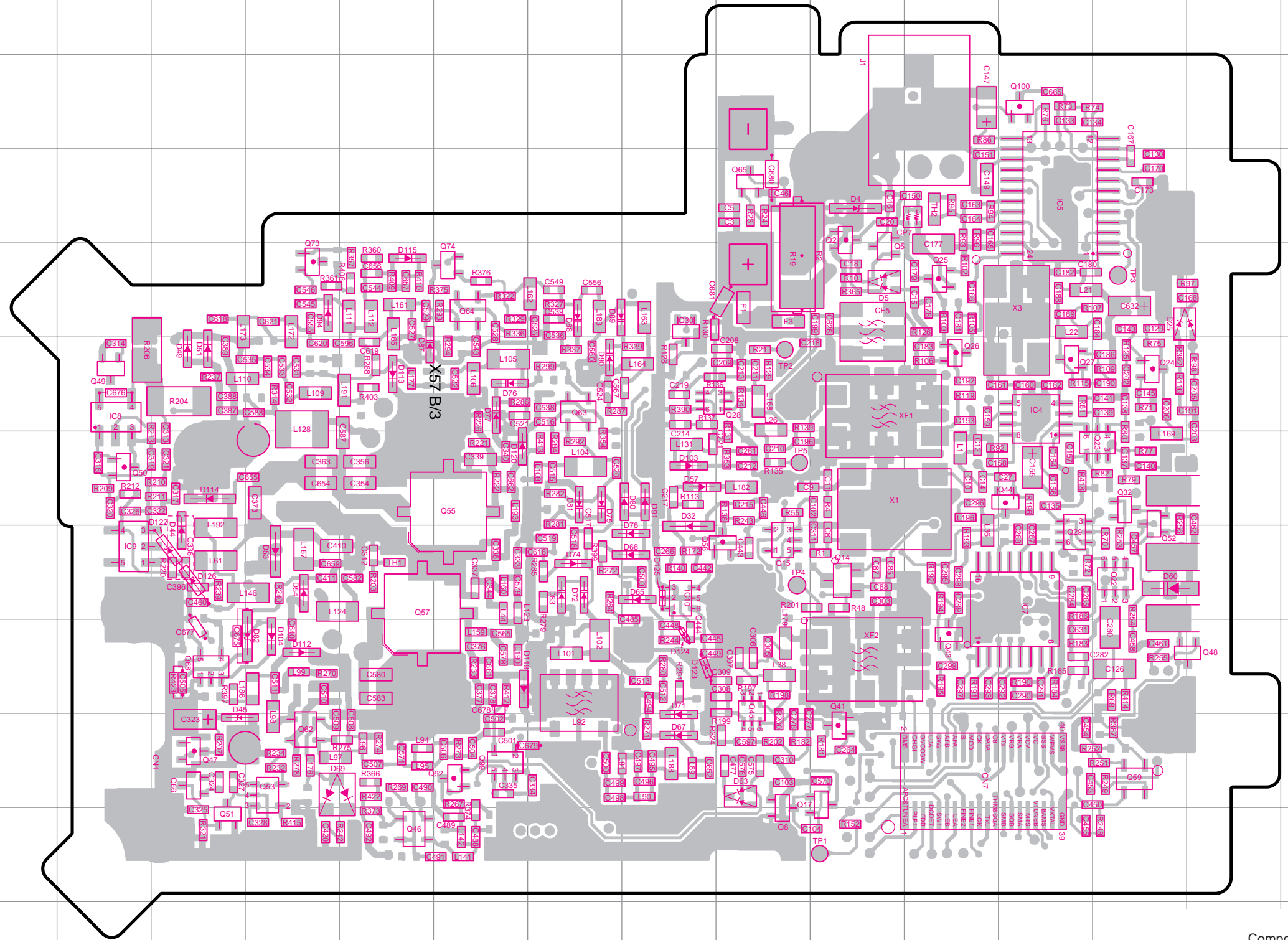

DTA114YE
DTA143ZE
DTC123JE
2SC4617
2SC5009
2SC5108

2SK1830
2SK3019

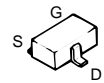

UMX2N

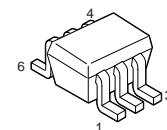

3SK320

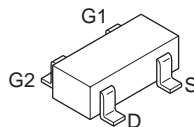

SSM3J05FU
UPA672T

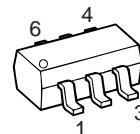

2SJ243
2SK1824

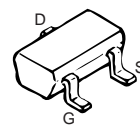

LMC7101BIM5

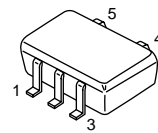

MT6C03AE

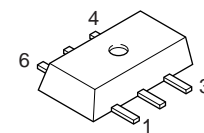

TA31136FN

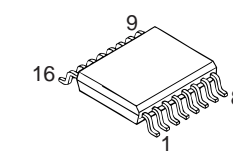

UPC2746TB

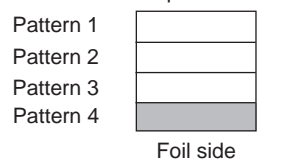
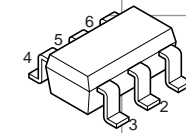

TH-F6A/F7E PC BOARD VIEW

TX-RX UNIT (X57-686X-XX) (B/3) Component Side View + Foil Side View

DTA114YE
DTA143ZE
DTC123JE
DTC144EE
2SC4226
2SC4617
2SC4725
2SC5009
2SC5108

2SD1760

2SC5192

UMX2N

2SK1830
2SK3019

3SK320

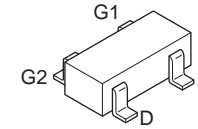
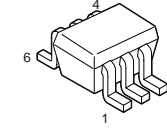
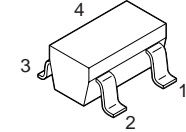
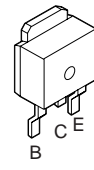

TX-RX UNIT(B/3) (Component side + Foil side)

Ref. No.	Address	Ref. No.	Address	Ref. No.	Address
IC1	3E	D83	8I		
IC2	8E	Q73	5L		
IC3	7H	Q74	5J		
IC4	6D	Q76	5K		
IC5	4D	Q92	10J		
IC6	9E	Q93	7G		
IC7	8D	Q94	8F		
IC8	6N	Q95	10K		
IC9	8N	Q96	10L		
IC10	8H	Q97	10H		
IC11	10I	Q98	11D		
Q1	5F	Q99	10J		
Q2	4F	Q100	3D		
Q3	3E	Q114	7M		
Q4	5F	D1	11F		
Q5	5F	D2	4G		
Q8	11G	D4	4F		
Q11	9G	D5	5F		
Q12	7F	D6	4E		
Q14	8F	D7	3E		
Q15	8G	D8	8D		
Q17	10F	D20	7D		
Q19	6H	D24	8D		
Q21	7G	D25	5C		
Q22	8C	D28	11H		
Q23	7C	D29	7D		
Q24	6C	D32	8H		
Q25	5E	D33	10E		
Q26	6E	D41	10H		
Q27	6D	D44	8M		
Q28	6H	D45	10M		
Q29	8D	D49	6M		
Q30	5H	D51	6M		
Q32	7C	D52	5M		
Q40	10F	D52	5M		
Q41	10F	D53	8L		
Q43	9E	D54	8L		
Q44	7D	D54	8L		
Q45	9G	D54	8L		
Q46	11K	D57	7H		
Q47	10M	D57	7H		
Q48	9C	D58	9D		
Q49	6N	D59	9C		
Q50	7N	D60	8C		
Q51	11M	D62	8M(K)		
Q52	8C	D62	9L(J,E,T)		
Q53	11L	D63	10G		
Q55	7J	D65	8H		
Q56	9I	D67	10H		
Q57	8K	D68	8H		
Q58	8G	D69	10L		
Q59	10C	D70	8L		
Q62	10L	D71	10H		
Q63	6I	D72	8I		
Q64	5J	D73	7M		
Q65	4G	D74	8I		
Q66	10M	D75	7I		
Q68	9M	D76	6J		
Q71	6I	D77	6J		
Q72	6J	D78	8H		
		D80	7I		
		D81	7I		
		D82	9M		

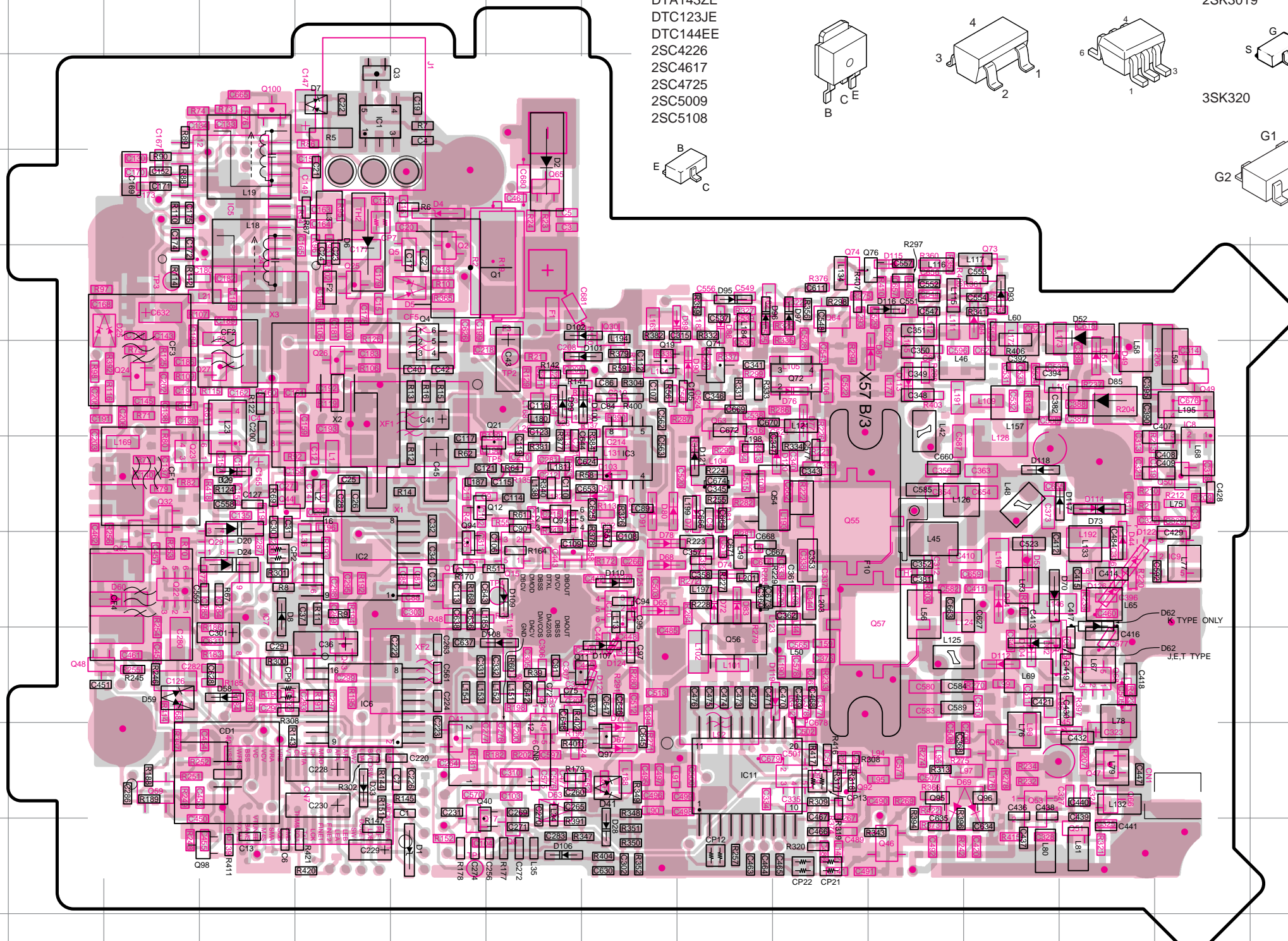

HN1K02FU

SSM3J05FU
UPA672T

2SJ243
2SK1824

LMC7101BIM5

MT6C03AE

LM3420-8.4

LMX2326TMX

TA31136FN

UPC2746TB

BU2099FV

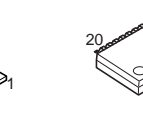
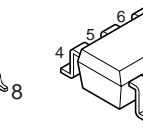
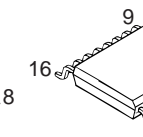
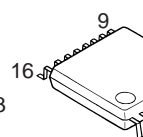
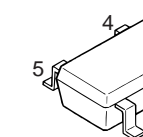
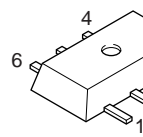
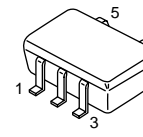
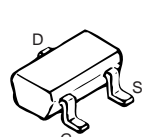
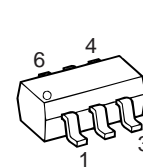
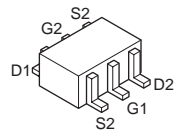

● Connect 1 and 4.

Component side

Pattern 1

Pattern 2

Pattern 3

Pattern 4

Foil side

PC BOARD VIEW

TH-F6A/F7E

TX-RX UNIT VCO SECTION (X57-636X-XX) (C/3) Component Side View

DTC144EE
2SC4617
2SC5009
2SC5108



HN1J02FU

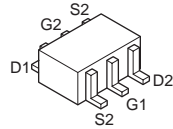

MT6C03AE

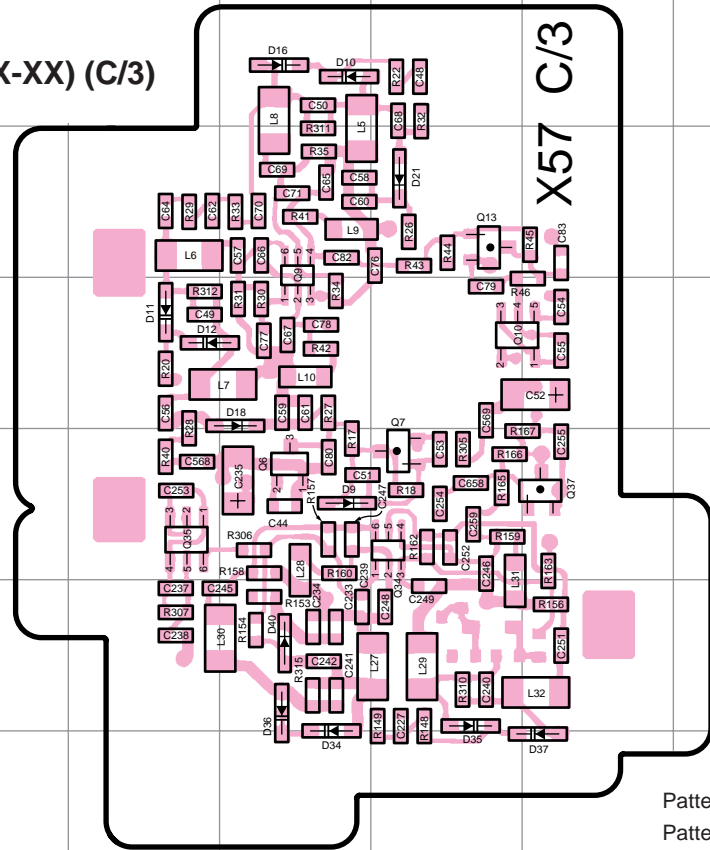
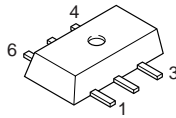

VCO SECTION(C/3) (Component side)

Ref. No.	Address
Q6	5E
Q7	5F
Q9	3E
Q10	4F
Q13	3F
Q34	5F
Q35	5D
Q37	5G
D9	5E
D10	3E
D11	4D
D12	4D
D16	2E
D18	4E
D21	3F
D34	6E
D35	6F
D36	6E
D37	7G
D40	6E

Component side

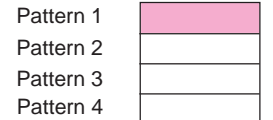

Foil side

TX-RX UNIT VCO SECTION (X57-636X-XX) (C/3) Foil Side View

DTC144EE
2SC4617

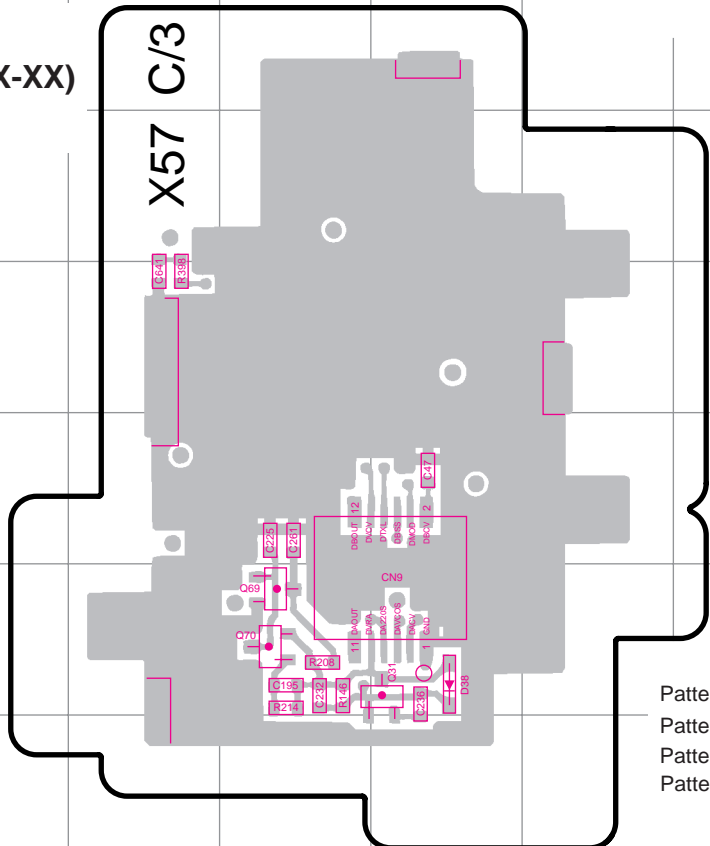

VCO SECTION(C/3) (Foil side)

Ref. No.	Address
Q31	12F
Q69	12E
Q70	12E
D38	12F

Component side

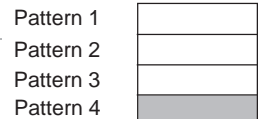

Foil side

TH-F6A/F7E

PC BOARD VIEW

Downloaded by
RadioAmateur.EU

TX-RX UNIT VCO SECTION (X57-636X-XX) (C/3) Component Side View + Foil Side View

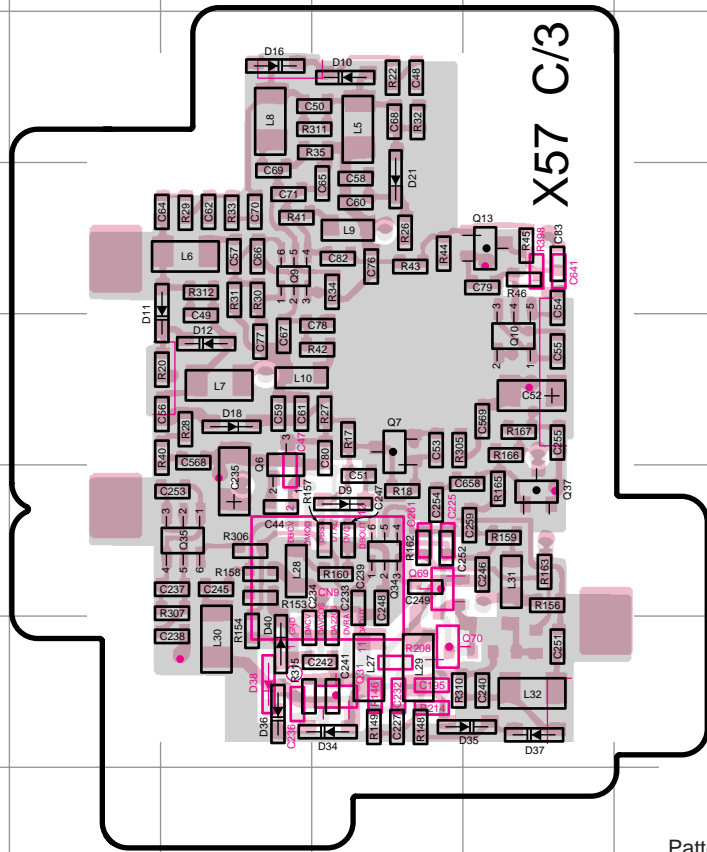

VCO SECTION(C/3)
(Component side + Foil side)

Ref. No.	Address
Q6	7D
Q7	6E
Q9	5D
Q10	6F
Q13	5F
Q31	8E
Q34	7E
Q35	7D
Q37	7F
Q69	7E
Q70	8E
D9	7E
D10	4E
D11	6C
D12	6D
D16	4D
D18	6D
D21	5E
D34	8E
D35	8F
D36	8D
D37	8F
D38	8D
D40	8D

● Connect 1 and 4.

Component side

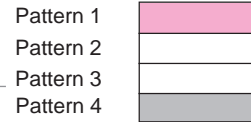

Foil side

DTC144EE
2SC4617
2SC5009
2SC5108



HN1J02FU

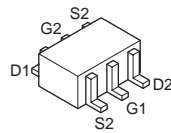

MT6C03AE

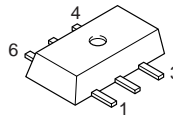

SCHEMATIC DIAGRAM TH-F6A/F7E

TX-RX UNIT
(X57-636X-XX) (B/3)

TX-RX UNIT (VCO SECTION)
(X57-636X-XX) (C/3)

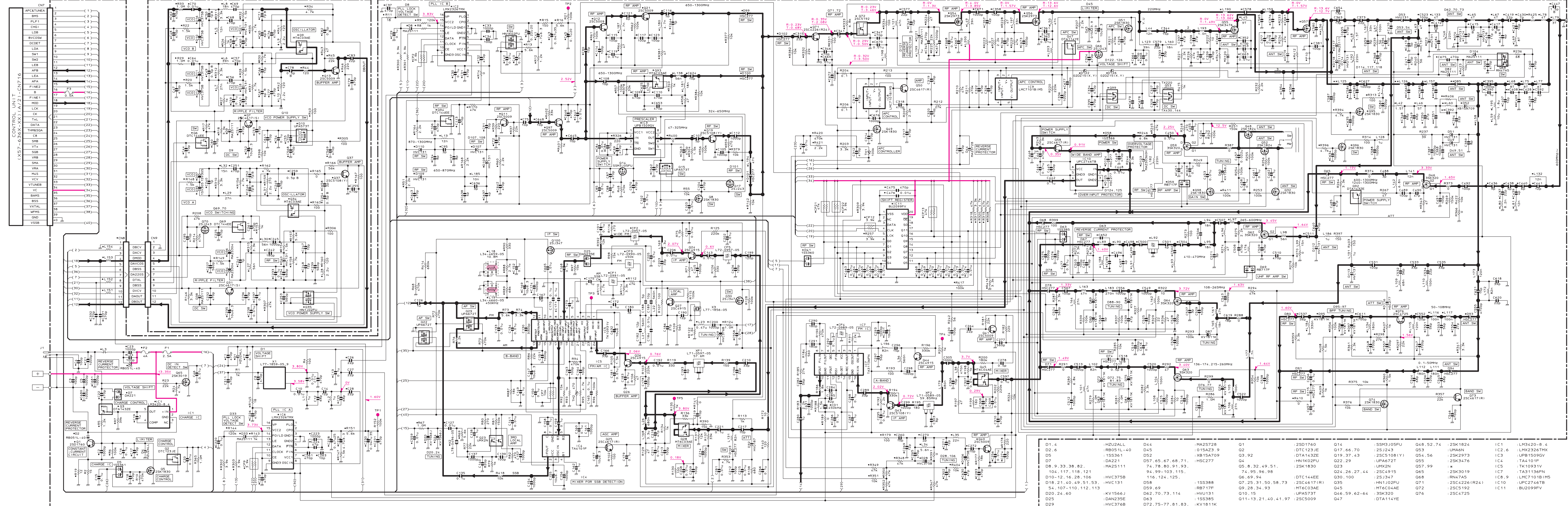

D1.4	:HZU2ALL	D44	:MA25728	01	:2SD1760	Q14	:SSM3J05FU	Q48.52.74	:2SK1824	IC 1	:LM320-8.4
D2.6	:RB051L-40	D45	:015A23.9	02	:DTC123JE	Q11.66.70	:2S1243	Q53	:UMAG6N	IC 2	:LMX2324TX
D5	:1SS361	D52	:XB15A709	03.92	:DTA1432E	Q19.37.43	:2SC5108(Y)	Q54.56	:2SK2973	IC 3	:UPB1509VF
D7	:DA221	D57.65.67.68.71	:HSC277	04	:HN1K02FU	Q22.29	:UPA672T	Q55	:2SK3476	IC 4	:TA4101F
D8.9.33.38.82	:MA2S111	74.78.80.91.93.				Q5.8.32.49.51.	:2SK1830	Q23	:UMK2N	IC 5	:TK10931V
D10-12.16.28.106	:HVC3758	116.124.125.				74.95.96.98		Q24.26.27.44	:2SC4915	Q65	:2SK3019
D18.21.40.49.51.53.	:HVC131	D58	:1SS388	06.69.94	:DTC144EE	Q30.100		Q25.28.29	:2S1347	Q68	:RN47AS
54.107-110.112.113		D59.69	:RB717F	07.25.31.50.58.73	:2SC4617(R)	Q35	:HN1J02FU	Q71	:2SC4226(R24)	IC 8	:LMC7101BMS
		D29	:MT6C03AE	Q45	:MTC03AE	09.28.34.93		Q72	:2SC5192	IC 9	:UPC2746TB
D20.24.60	:KV1566J	D62.70.73.114	:HVC131	Q10.15	:UPA573T	Q46.59.62-64	:3KA520	Q76	:2SC4725	IC 11	:BU2099VF
D34.36	:MA2S304	D63	:DAN235E								
D35.37	:1SV305	D122.126	:1SS385								
D41	:1SV360	D123	:KV181K								

TH-F6A/F7E SCHEMATIC DIAGRAM

Downloaded by
RadioAmateur.EU

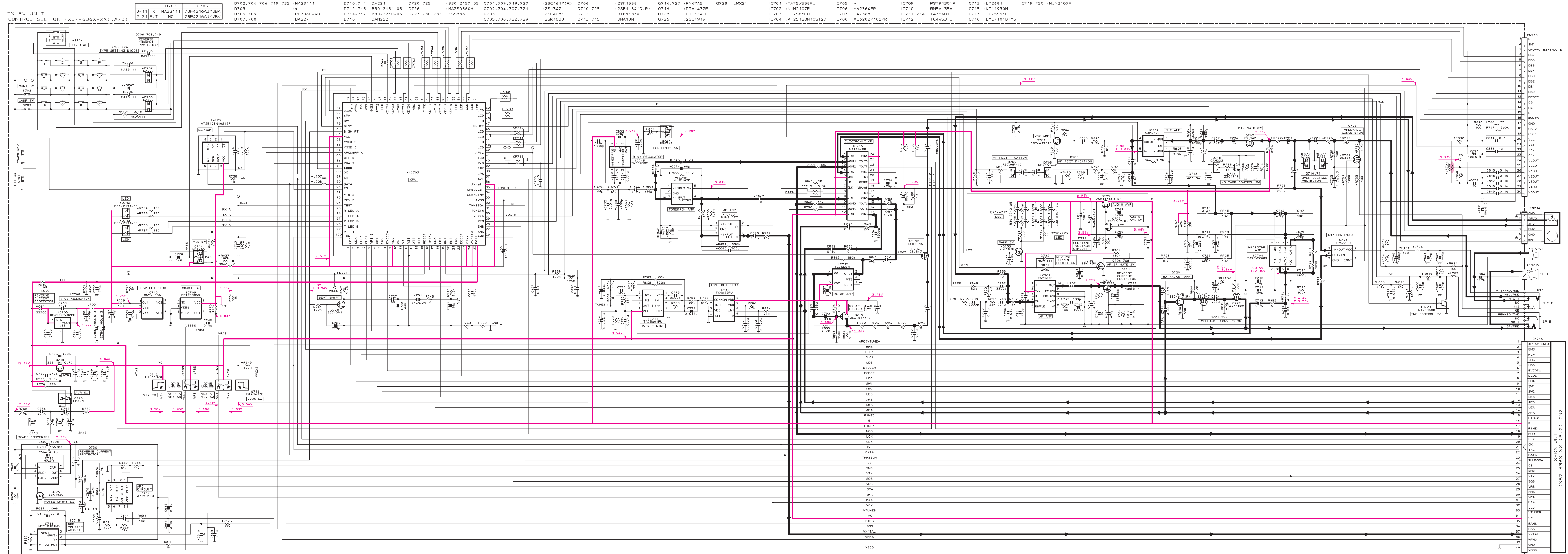

2

3

4

5

6

7

TH-F6A/F7E TH-F6A/F7E

BLOCK DIAGRAM

Downloaded by
RadioAmateur.EU

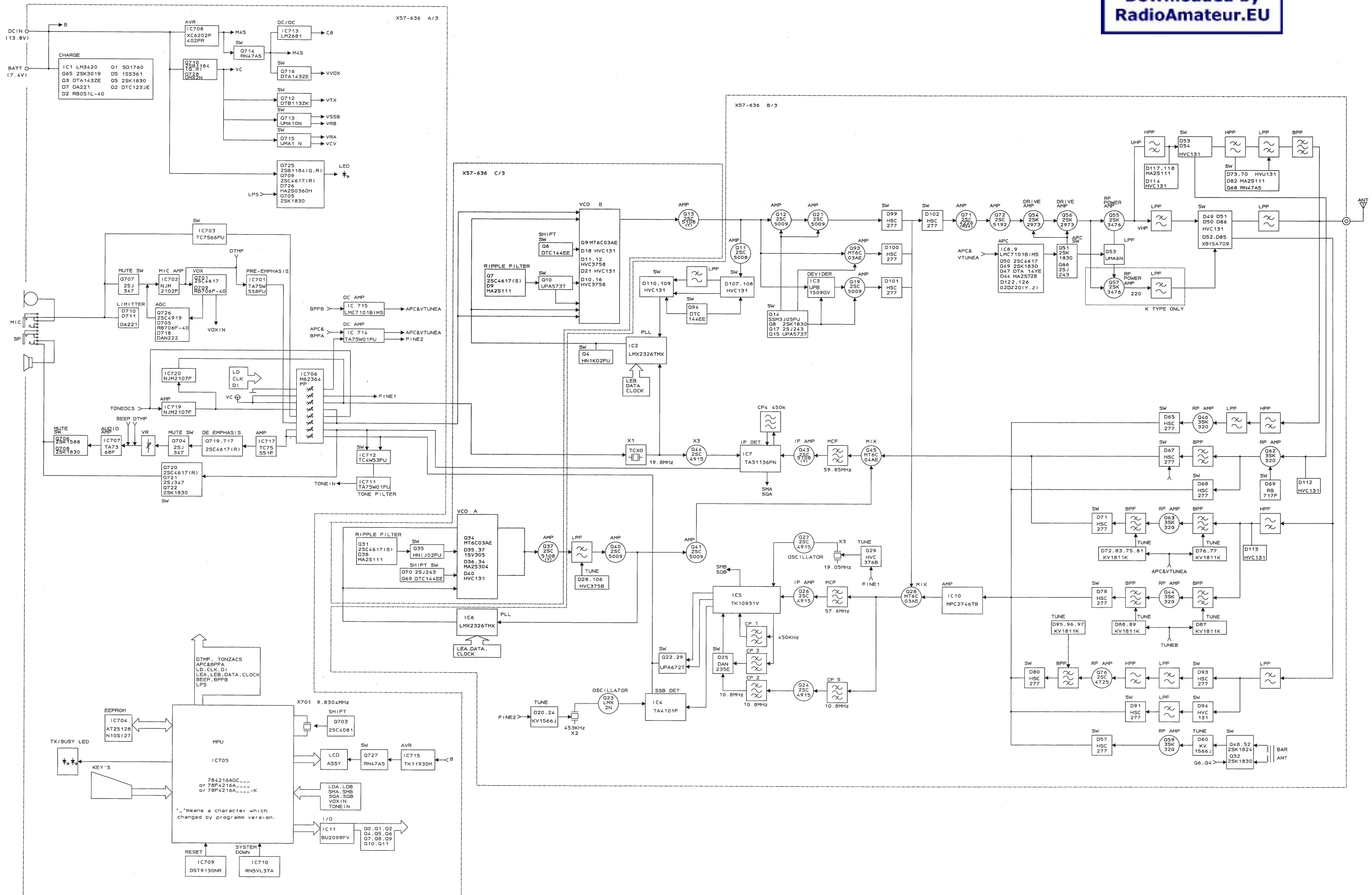

TH-F6A/F7E TH-F6A/F7E

LEVEL DIAGRAM

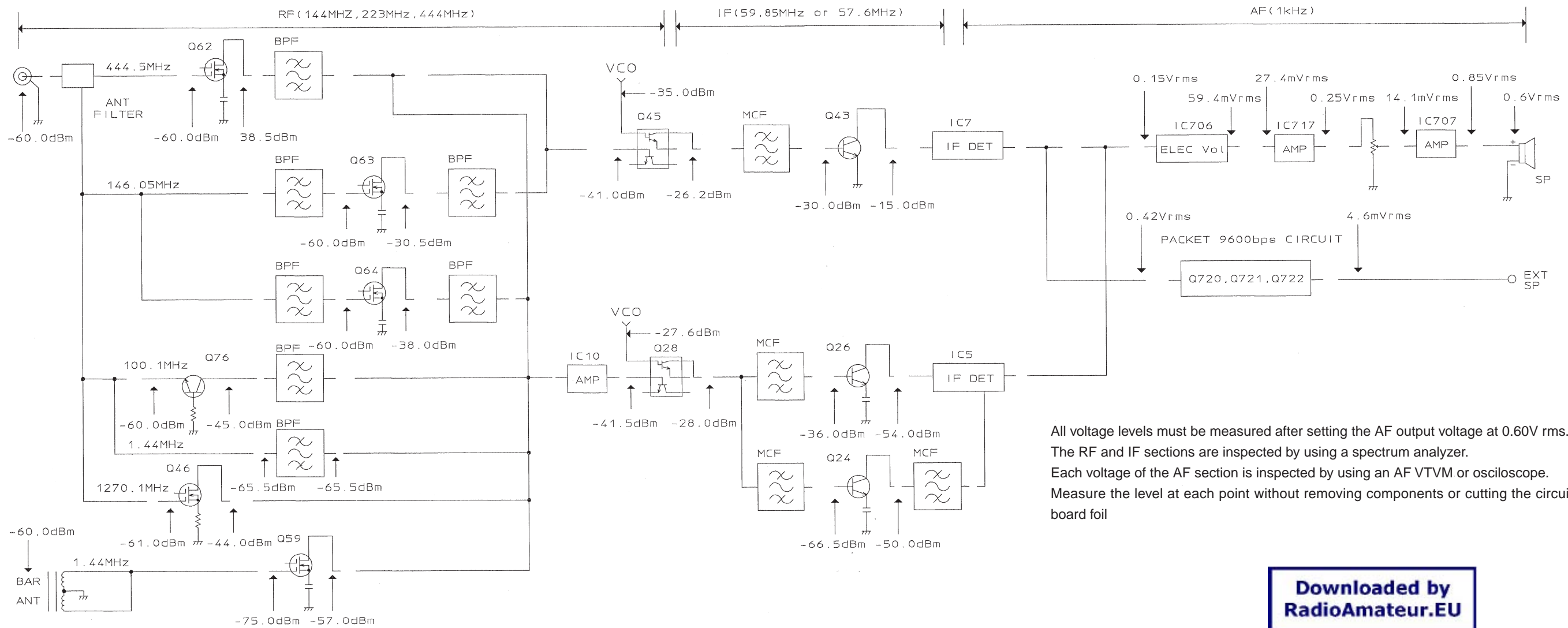
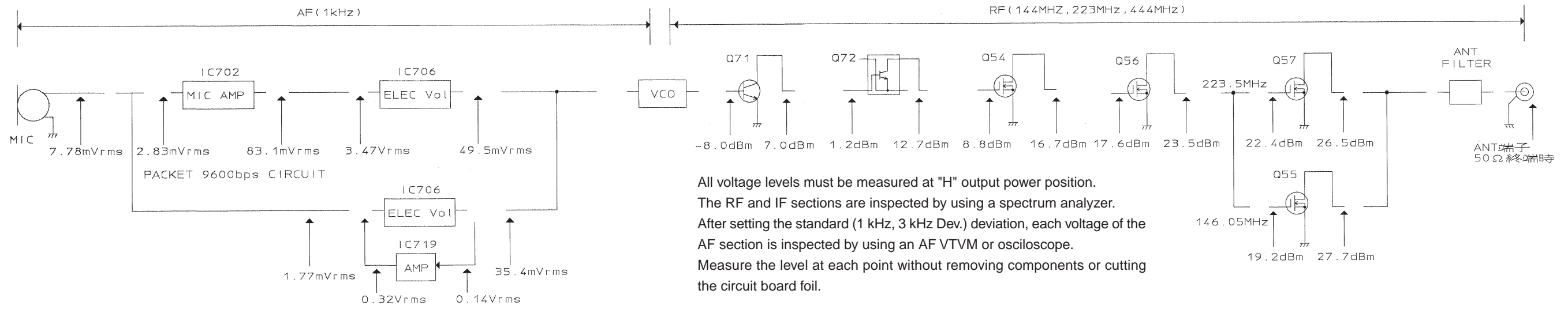

Downloaded by
RadioAmateur.EU

OPTIONS

BT-13

Battery Case (4 AA/ LR6)

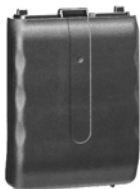

BT-13 PARTS LIST

Ref. No.	Address	New parts	Parts No.	Description	Destination
		*	A02-3729-08	CABINET	
		*	F07-1864-08	COVER	

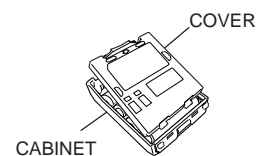

PB-42L

Li-ion Battery Pack
(7.4V, 1500 mAh)



PG-2W

DC Power Cable



PG-3J

Cigarette Lighter Power
Cable



SMC-32

Speaker Microphone



SMC-33

Speaker Microphone
(with PF keys)



SMC-34

Speaker Microphone
(with PF keys and VOL control)



EMC-3

Clip Microphone with
Earphone



HMC-3

Headset (with VOX/PTT)



KHS-21

Headset



TH-F6A/F7E

SPECIFICATIONS

General		TH-F6A	TH-F7E
Number of memory channels		400 channels +35 special function memories	400 channels +34 special function memories
Antenna impedance(Connector type)		50 (SMA)	
Operating Voltage	DC IN Jack	DC 12.0 ~ 16.0 V (13.8 V normal)	
	Battery terminal	DC 5.5 ~ 7.5 V (7.4 V normal)	
Grounding method		Negative ground	
Current	Transmit wiht H, 13.8 V (DC IN)	2.0 A or tess	
	Transmit wiht H, 7.4 V (PB-42L)	2.0 A or tess	
	Transmit wiht L, 7.4 V (PB-42L)	0.8 A or tess	
	Transmit wiht EL, 7.4 V (PB-42L)	0.5 A or tess	
	Receive (no signal)	100 mA (Single band) / 170 mA or less (dual-band)	
	Battery Saver ON (Average)	30 mA (single band) / 35 mA or less (dual -band)	
Usable temperature range		-20° C ~ 60° C(-4° F ~ 140° F) -10° C ~ 50° C (+14° F ~ 122° F) with PB-42L	
Frequency stability		Within ±8 ppm (-20° C ~ 60° C) Within ±5 ppm (-10° C ~ 50° C)	
Dimensions (W x H x D Projections not included)		58 x 87 x 30 mm / 2.3" x 3.4" x 1.2" with the PB-42L 58 x 87 x 38 mm / 2.3" x 3.4" x 1.5" with the BT-13	
Weight		Approx. 250 g / 0.55 lb with the PB-42L Approx. 280 g / 0.62 lb with the BT-13	

Transmitter		TH-F6A	TH-F7E
Transmit Mode		F3E (FM) / F2D (FM)	
Frequency range	2 m band	144 ~ 148 MHz	144 ~ 146 MHz
	1.25 m band	222 ~ 225 MHz	N/A
	70 cm band	430 ~ 450 MHz	430 ~ 440 MHz
Output Power	2 m band / 1.25 m band / 70 cm band	DC-IN jack (13.8 V)	H:5.0 W (approx.) L:2.0 W (approx.) EL:0.5 W (approx.)
		PB-42L (7.4 V)	H:5.0 W (approx.) L:0.5 W (approx.) EL:0.05 W (approx.)
		BT-14 (6.0 V)	H:0.5 W (approx.) L:0.3 W (approx.) EL:0.05 W (approx.)
Modulation		Reactance	
Maximum frequency deviation		±5 kHz (FM) / ±2.5 kHz (NFM)	
Squiros emissions (at htigh transmit power)		-60 dB or less	
Microhpone impedance		2 k	

SPECIFICATIONS

Receiver		TH-F6A	TH-F7E
Receive mode	A-band	F3E (FM) / F2D (FM) / F1D (FM)	
	B-band	J3E (LSB, USB)/ A1A (CW): 0.1 MHz ≤ f < 470GHz A3A (AM) / F3E (FM) / F2D (FM): 0.1 MHz ≤ f < 1.3GHz	
Circuit type	LSB / USB / CW / AM / FM	Double superheterodyne	
	WFM	Single superheterodyne	
Frequency range	A-band	137 ~ 174 MHz 216 ~ 260 MHz 410 ~ 470 MHz	144 ~ 146 MHz 430 ~ 440 MHz
	B-band	0.1 ~ 1.8 MHz 1.8 ~ 29.7 MHz 29.7 ~ 54 MHz 54 ~ 108 MHz 108 ~ 137 MHz 137 ~ 174 MHz 174 ~ 216 MHz 216 ~ 400 MHz 400 ~ 470 MHz 470 ~ 806 MHz 806 ~ 824 MHz 849 ~ 869 MHz 894 ~ 1300 MHz	0.1 ~ 1.71 MHz 1.71 ~ 29.7 MHz 29.7 ~ 87.5 MHz 87.5 ~ 108 MHz 108 ~ 137 MHz 137 ~ 174 MHz 174 ~ 230 MHz 230 ~ 400 MHz 400 ~ 470 MHz 470 ~ 862 MHz 862 ~ 1300 MHz
Intermediate Frequency (IF)	A-band	1st IF: 59.85 MHz 2nd IF: 450 kHz	
	B-band	1st IF: 0.1 MHz ~ 1.3 GHz: 57.60 MHz (LSB / USB / CW / AM / FM) : 29.7 MHz ~ 1.3 GHz: 10.8 MHz (WFM) 2nd IF : 0.1 MHz ~ 1.3 GHz: 450 kHz (LSB / USB / CW / AM / FM)	
Sensitivity	A-band	FM (12 dB SINAD) 2 m / 1.25 m (TH-F6A only) / 70 cm amateur radio bands: 0.18 μV or less	
	B-band	FM (12 dB SINAD) 5 ~ 108 MHz: 0.40 μV 118 ~ 144 MHz: 0.28 μV 144 ~ 225 MHz: 0.22 μV 225 ~ 250 MHz: 0.89 μV 380 ~ 400 MHz: 0.40 μV 400 ~ 450 MHz: 0.22 μV 450 ~ 520 MHz: 0.40 μV 520 ~ 700 MHz: 7.08 μV 800 ~ 950 MHz: 1.26 μV 950 ~ 1300 MHz: 0.40 μV WFM (30 dB S/N) 50 ~ 108 MHz: 3.16 μV 150 ~ 222 MHz: 2.82 μV 400 ~ 500 MHz: 3.98 μV	AM (10 dB S/N) 0.3 ~ 0.52 MHz: 7.08 μV 0.52 ~ 1.8 MHz: 2.24 μV 1.8 ~ 50 MHz: 0.89 μV 118 ~ 250 MHz: 0.40 μV 380 ~ 500 MHz: 0.40 μV LSB / USB (10 dB S/N) 3 ~ 30 MHz: 0.45 μV 30 ~ 50 MHz: 0.40 μV 144 ~ 148 MHz: 0.22 μV 430 ~ 450 MHz: 0.22 μV *All values are approximate
Squelch sensitivity		0.13 μV or less (Within 2 m / 1.25 m / 70 cm amateur radio bands)	
Selectivity		-6 dB / 12 kHz or less -40 dB / 28 kHz or less (Within 2 m / 1.25 m / 70 cm amateur radio bands)	
Audio output (10% distortion)		300 mW or higher (7.4 V, 8Ωload)	

TH-F6A/F7E

KENWOOD CORPORATION

14-6, Dogenzaka 1-chome, Shibuya-ku, Tokyo 150-8501, Japan

KENWOOD SERVICE CORPORATION

P.O. BOX 22745, 2201 East Dominguez Street, Long Beach, CA 90801-5745, U.S.A.

KENWOOD ELECTRONICS CANADA INC.

6070 Kestrel Road, Mississauga, Ontario, Canada L5T 1S8

KENWOOD ELECTRONICS DEUTSCHLAND GMBH

Rembrücker Str. 15, 63150 Heusenstamm, Germany

KENWOOD ELECTRONICS BELGIUM N.V.

Mechelsesteenweg 418 B-1930 Zaventem, Belgium

KENWOOD ELECTRONICS FRANCE S.A.

13, Boulevard Ney, 75018 Paris, France

KENWOOD ELECTRONICS U.K. LIMITED

KENWOOD House, Dwight Road, Watford, Herts., WD1 8EB United Kingdom

KENWOOD ELECTRONICS EUROPE B.V.

Amsterdamseweg 37, 1422 AC Uithoorn, The Netherlands

KENWOOD ELECTRONICS ITALIA S.p.A.

Via G. Sirtori, 7/9 20129 Milano, Italy

KENWOOD IBERICA S.A.

Bolivia, 239-08020 Barcelona, Spain

KENWOOD ELECTRONICS AUSTRALIA PTY. LTD.

(A.C.N. 001 499 074)

16 Giffnock Avenue, Centrecourt Estate, North Ryde, N.S.W. 2113, Australia

KENWOOD ELECTRONICS (HONG KONG) LTD.

Unit 3712-3724, Level 37, Tower one Metroplaza, 223 Hing Fong Road, Kwai Fong, N.T., Hong Kong

KENWOOD ELECTRONICS TECHNOLOGIES(S) PTE LTD.

Sales Marketing Division

1 Ang Mo Kio Street 63, Singapore 569110



**Downloaded by
RadioAmateur.EU**